

Ultrasonic Cleaner Pulse Jet

W-357-1MPG

- Instruction Manual -

- Please carefully read this instruction manual before using this product.
- Please use the product correctly.
- Please keep this document where it can be easily accessed.



HONDA ELECTRONICS CO.,LTD.

Foreword

Thank you for purchasing the Ultrasonic Cleaner Pulse Jet.

This ultrasonic cleaner, using water flow, cleans fine contamination that cannot be removed by using only pure water. This process is done by ejecting ultrasonic water onto a semiconductor (e.g. silicon wafer).

This document describes how to use the device correctly and also lists important safety instructions to prevent injury, malfunction, damage (e.g. fire), etc. Please read this document carefully before using the device and be sure to follow the safety instructions.



Table of Contents

	<u>Page</u>
1. Safety Precautions	1
2. Safety Instructions	2
3. Components	8
4. Functions and Features	9
5. Device Installation and Cable Connection	10
6. Installing the Device – Cautions	15
7. Operation	17
8. Effective Ultrasonic Cleaning – Hints	22
9. MENU Operation	23
10. RS-422A	27
11. Generator - Outline View	30
12. Nozzle - Outline View	31
13. Cable (provided) - Outline View	32
14. Generator - Connection Diagram	33
15. Product Specifications	34
16. Precautions in Using the Device	37
Appendix 1: Alarm code list (W-357-1MPG)	38

1. Safety Precautions







1. Safety Precautions

The following signs describe safety hazards and damages according to the safety level.

 Danger	Incorrect use of the device may result in a critical accident and you may be killed or severely injured.
 Warning	Incorrect use of the device may result in being killed or severely injured.
 Caution	Incorrect use of the device may result in injury or damage to the device.

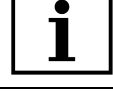
■ Signs and Safety symbols

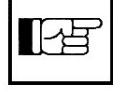
The following signs and symbols describe the cautions, hints, safety instructions and references.

	Don't		Read the instruction manual
	Instruction		
	Hint		Do not disassemble
	Reference page		Danger - Electrocutation



2. Safety Instructions

This device has been carefully manufactured to ensure safe use. However, if you don't follow the safety instructions described in this document, you may be injured or the device may be damaged.

Before you start using this device, please read this document carefully and learn how to operate the device safely and correctly.

2. Safety Instructions

2-1. DANGER - HIGH VOLTAGE

 Danger	HIGH VOLTAGE
	 No Disassembly

2. Safety Instructions

2-2. Basic Safety Instructions

Please carefully read and follow the safety instructions described in this section. If you ignore these safety instructions, an accident may occur that may kill or injure you.

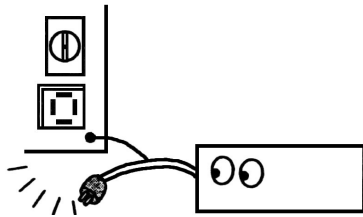

Connect the device to a power source by using a grounded outlet, or connect the ground cable to the ground terminal.

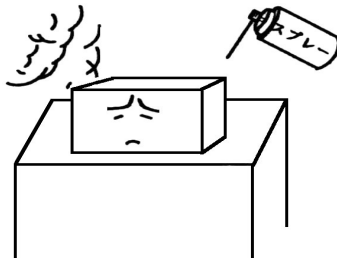

Do not use this device in an environment with inflammable or explosive gas.

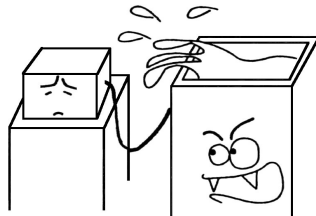

Do not subject the device to liquids. Do not place or immerse the nozzle in water.

2. Safety Instructions

Please carefully read and follow the safety instructions described in this section. If you ignore these safety instructions, you may be killed or severely injured.

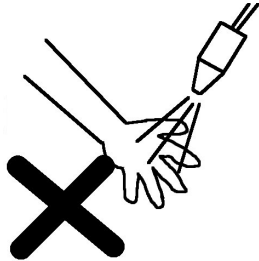

Do not touch the cleaning solution emitted from the nozzle tip while cleaning.



Carefully handle the cleaning and waste solutions. Learn first aid procedures well in advance. This will expedite treatment if you are exposed to or accidentally swallow the solution.



Objects heavier than 10kg should be handled by two or more persons or with hoisting equipment. Be careful not to fall. Be careful about back injuries.

2. Safety Instructions

2-3. Safety Precautions

Precautions when installing the device



- * Make sure to unplug the power cable when you connect a cable (e.g., power cable, output cable, optional cable).
- * Do not install the device where you cannot operate the power switch or connect/disconnect the power plug.
- * Install the device so the generator vent is not blocked.



- * The nominal power voltage of the generator is 100V-240V AC (single phase). Do not use any other type of power.
- * Do not use faulty or a damaged power cable or plug. Do not use a power cable or power that cannot be firmly connected to the power outlet.
- * Do not use a power cable that has a different rating.
- * Hold the plug firmly while completely inserting the power plug into the power outlet.
- * Do not pull the power plug out by holding onto the cable. Make sure to hold the plug when disconnecting it from the power outlet.
- * Do not turn on the unit without water flow. Make sure to use the minimum water flow of 0.9 L/min.
- * Make sure that there is no water leakage. Do not use a pump that has a pressure stronger than required. (Upper limit of water flow is 2.0 L/min.)

2. Safety Instructions

Safety precautions when operating the device



- * Do not touch the power cable or power outlet with wet hands.
- * Do not connect/disconnect the output connector with wet hands. Do not touch the nozzle accidentally.
- * If an alarm is output, and if you need to touch the device (e.g., cables, nozzle), except the operation panel, turn the power of the generator off first and then disconnect the power cable.



- * Need the knowledge of cleaning solution and waste solution. Safety precautions, first aid methods and / or any required notices for the cleaning solution in use are required to the operator.
- * Turn the power on/off by following the proper procedure.
- * Objects heavier than 10kg should be handled by two or more persons or with hoisting equipment.
Be careful not to fall
Be careful about back injuries.



- * Do not use the following materials as a cleaning solution.
 - Inflammable or explosive liquids (e.g., thinner, benzene, etc.)
- * Make sure to inspect the device before use.
- * If any of the problems described below occur when turning on the device, turn off the power immediately and contact your dealer.
 - Noise, heat, smoke
 - No LCD display
 - ALARM is displayed again after turning the power off/on.

2. Safety Instructions

Safety in maintenance



- * Do not open the cover of the device.
- * Only qualified maintenance personnel should maintain the device.
- * If the generator gets wet, turn the primary power off immediately and then turn off the power switch. Contact your dealer for further instructions.
- * If you feel electricity when you touch the generator, turn off the primary power immediately, then turn off the power switch. Next, check if the device has been properly grounded. Contact your dealer for further instructions.
- * Use the specific nozzle for the device. Make sure the nozzle model and the device model match.
- * To replace the nozzle, turn off the power switch first and disconnect the output connector.



- * If any of the problems described below occur when turning on the device, turn off the power immediately and contact your dealer.
 - Noise, heat, smoke
 - No LCD display
 - ALARM is displayed again after turning the power off/on.

3. Components

3. Components

- | | | |
|---|---|---|
| ① | Generator | 1 |
| ② | Nozzle (with output cable (5m)) | 1 |
| ③ | Power cable
* 100V (2m) or 200V (2.4m) | 1 |
| ④ | 3P-2P grounding conversion adaptor
* Not attached to the power cable (200V (2.4m)) | 1 |
| ⑤ | Output connector holding plate | 1 |
| ⑥ | Control cable (5m)
* Common cable (SENSOR, REMOTE, ALARM, 4-20mA) | 4 |
| ⑦ | Instruction Manual (This document) | 1 |

Generator

Front panel

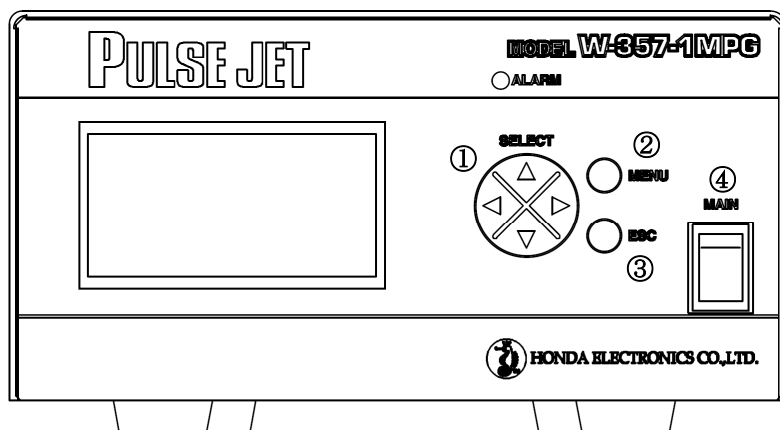

①	SELECT key
②	MENU key
③	ESC key
④	Power switch (MAIN)

Rear panel

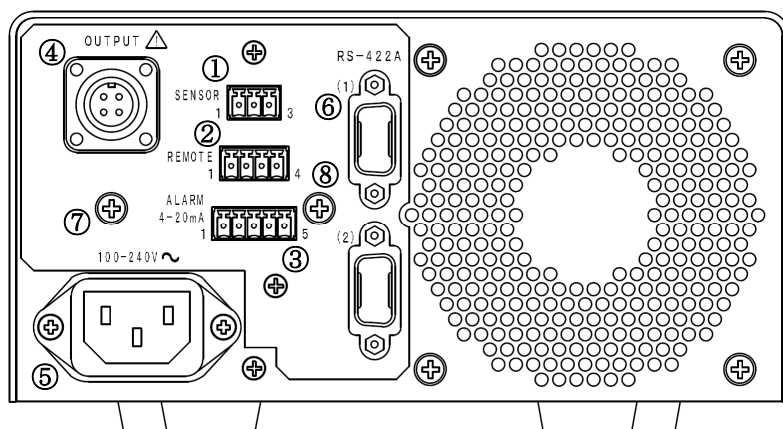

①	SENSOR connector
②	REMOTE connector
③	ALARM/4-20mA connector
④	Output connector
⑤	Power socket
⑥	RS-422A connector
⑦	Screw for fixing output connector holding plate
⑧	Screw for connecting ALARM/4-20mA cable shield

**"Generator" in this document means a box that includes the LCDs and switches.

"Device" in this document means the whole device (W-357-1MPG) including the generator, the nozzle, and the cables.

4. Functions and Features

4. Functions and Features

- ① The device (W-357-1MPG) is a water flow ultrasonic cleaning unit. It uses 1MHz ultrasonic waves; the maximum output is 40W. The device consists of the generator and the nozzle with an internal ultrasonic transducer, which are connected by the cable.
- ② The output is controlled by constant power to stabilize the energy provided to the transducer. The frequency to drive the transducer tracks and stabilizes the voltage/current phase of the transducer. Synchronizing frequency tracking and constant power control stabilizes ultrasonic wave oscillation from the transducer as well as controls the loss of the generator. As a result, the generator can emit stabilized ultrasonic waves continuously by responding to the changes of water temperature and ambient temperature.
- ③ The generator and the nozzle have been optimally calibrated at the factory.
Note: The generator has a calibration function (self adjustment function) for optimal operation. If you replace the nozzle, calibrate the generator and the nozzle.



For details on the calibration procedure, see "9-7 CALIBRATION" (Pages 24, 25 and 26).

- ④ The generator calculates and monitors the impedance of the transducer while the generator is emitting the ultrasonic waves. If the relationship between frequency and impedance changes, the mechanical load to the transducer is changing or the transducer is deteriorating. If the impedance changes excessively, the transducer may not output stable ultrasonic waves. If this occurs, the generator outputs an alarm.
 - ⑤ If the device detects an error in the generator and the nozzle, it outputs an alarm. The device can detect the following errors: disconnected cable, short circuit, abnormal power, overcurrent, abnormal transducer impedance and insufficient water flow.
 - ⑥ You can set the power output by key input or RS-422A communication. You can turn ON/OFF by REMOTE connector (Separate line).
- W-357-1MPG - Major functions and Features
 - Constant power control
 - Phase lock generator
 - Transducer's impedance monitoring
 - No calibration required to replace the nozzle of the same specification
 - Self-calibration function is installed (CALIBRATION)
 - Sophisticated error detection
 - RS-422A, 4-20mA
 - Input power range: 100 - 240V AC

5. Device Installation and Cable Connection

5. Device Installation and Cable Connection

5-1. Caution

- ① When you connect the nozzle, output cable and optional cables, first disconnect the power plug.
- ② Do not install the device where the generator vent is blocked or where you cannot operate the power switch or connect/disconnect the power plug.
- ③ Place the generator on a horizontal platform that is not subject to vibration. Securely lock the nozzle with a clamp.

5-2. Connecting the Nozzle

- ① Make sure the power switch is turned OFF.
 - ② Connect the plug (nozzle cable) to the output connector (generator (rear side)).
 - ③ Attach the holding plate (output connector) to the connected plug and lock the plug with the screws.
- * This holding plate (output connector) prevents you from accidentally removing the plug while the device is in operation. However, if you embed the generator in another device, you don't need to install the holding plate (output connector).



See "3. Components" (Page 8)
See "14. Generator - Connection Diagram" (Page 33)

5-3. Connecting the Power Cable

- ① Make sure that the power switch (generator) is turned OFF.
- ② Connect the power cable (provided) to the power socket (generator (Rear side)).
- ③ Connect the power cable to the primary power source.



Caution

The power voltage for the generator is "100V - 240V AC (Single-phase) 50/60Hz". Do not use any other power type. If you use a different power, the device may fail or cause an accident (e.g., fire).

Pin 1 ——— Nominal voltage: 100V - 240V AC
Pin 2 ———
Pin 3 ——— GND

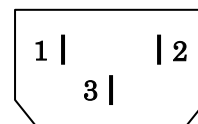

5. Device Installation and Cable Connection

5-4. Connecting the SENSOR Connector

- ① Connect the 3-pin connector (provided) to which the control cable is connected to the SENSOR connector (generator (rear-side)). Connect the RED line and WHITE line of the control cable (connected to SENSOR connector) to OUTPUT of the flow switch. (When the water flow exceeds the critical water flow (0.9 L/min. or more), the flow switch turns "ON" (CLOSE).)

Pin 1	SENSOR signal input (+5V pull-up)	RED line	→ Flow switch
Pin 2	GND	WHITE line	→ Flow switch
Pin 3	GND	SHIELD line	→ Shield

- ② Flow switch - Use conditions

Flow rate	0.9 (L/min.) or more	→ ON (CLOSE)
Flow rate	Less than 0.9 (L/min.)	→ OFF (OPEN)
Contact capacity	DC12V 18mA or more	

- ③ Connection Example

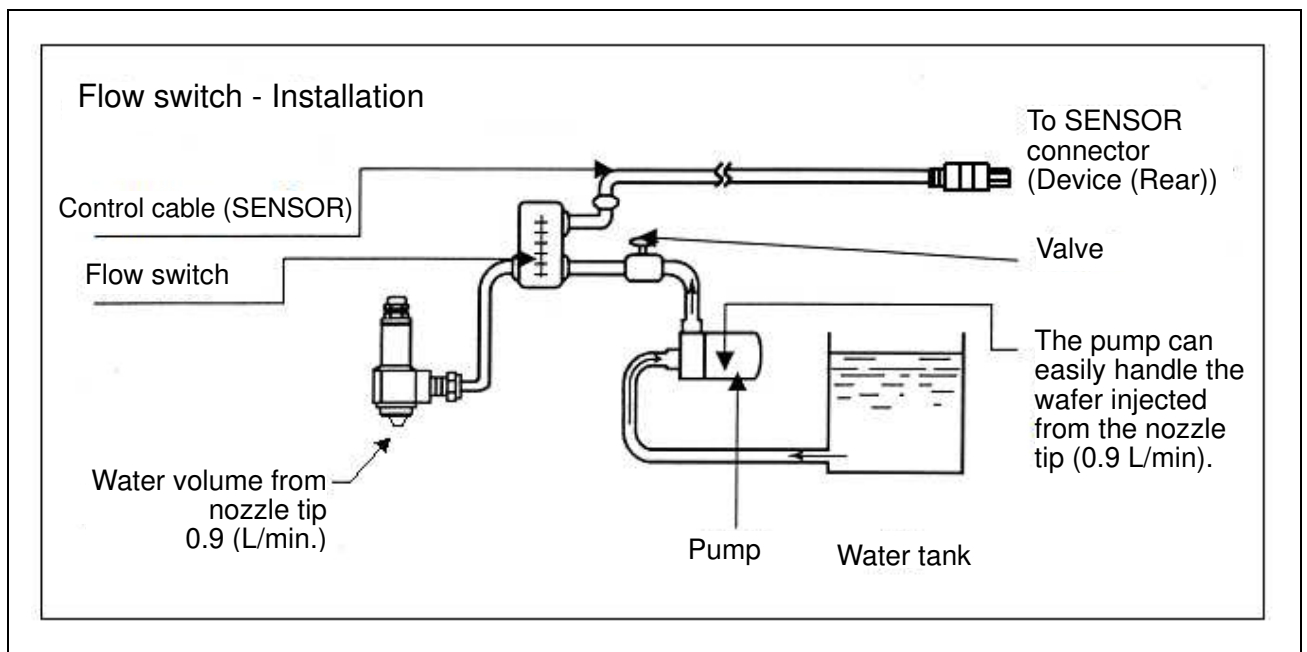

* The flow switch is not provided. The customer should provide it.

5. Device Installation and Cable Connection

5-5. Connecting the REMOTE connector

- ① Connect the control cable to the 4-pin connector (provided). Connect the control cable to the REMOTE connector (generator (rear-side)). (The REMOTE connector allows you to turn ON/OFF the emission of the ultrasonic waves.)
- ② You can turn ON/OFF to emit the ultrasonic waves by tuning RED and WHITE lines to "CLOSE/OPEN" of the control cable connected to REMOTE connector.

* If the REMOTE connector is not connected, the generator remains in the "OPEN" state and "Emitting the ultrasonic waves" is turned "OFF".

③ Pin number

Pin 1	REMOTE signal input (+5V pull-up)	RED line → REMOTE driving circuit
Pin 2	GND	WHITE line → REMOTE driving circuit (COM)
Pin 3	GND	SHIELD line → SHIELD
Pin 4	Reserved	BLACK line → Reserved

④ Connection - Example

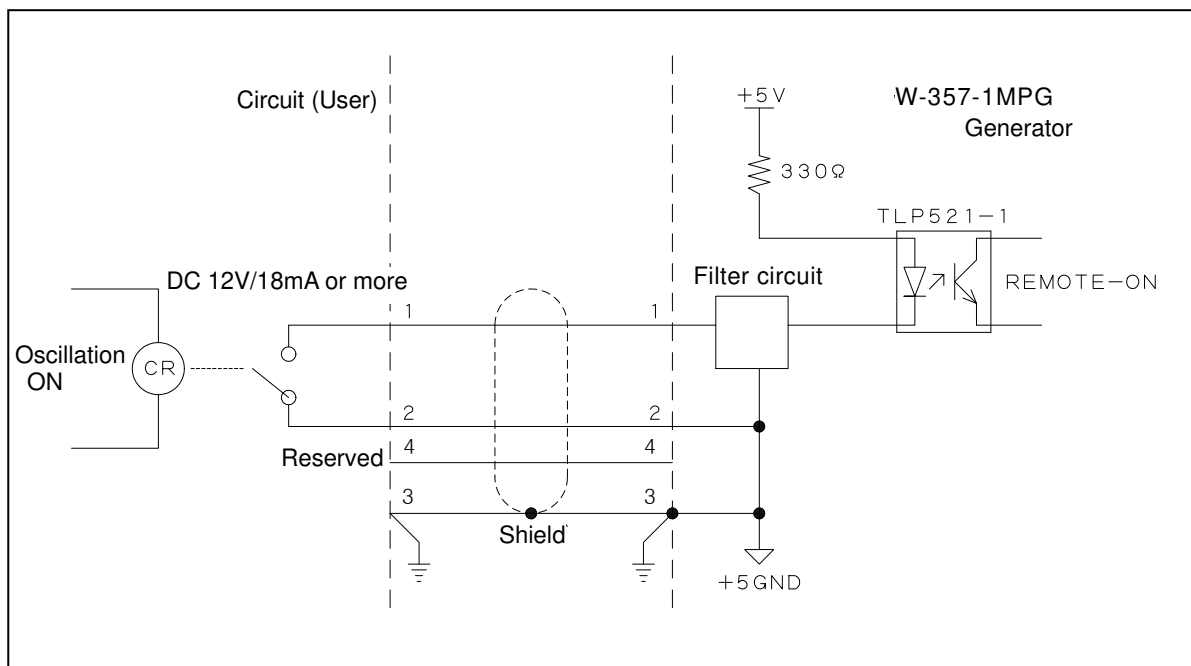

5. Device Installation and Cable Connection

5-6. Connecting the ALARM cable

- ① To install a warning buzzer or warning light, connect the control cable to the 5-pin connector (provided) and connect the control cable to ALARM/4-20mA (generator (rear)). (Pins 1 - 3 are used in ALARM.)
- ② To output a warning, "C-contact" of the mechanical relay is used. The rating is DC24V/0.5A (max).
- ③ Pin number

Pin 1	Alarm OFF	RED line	→ User's circuit (When ALARM , OFF)
Pin 2	Alarm ON	WHITE line	→ User's circuit (When ALARM, ON)
Pin 3	Relay's common terminal	BLACK line	→ User's circuit (Common)

* Design the control circuit based on the conditions described in ② and ③.

④ Connection - Example

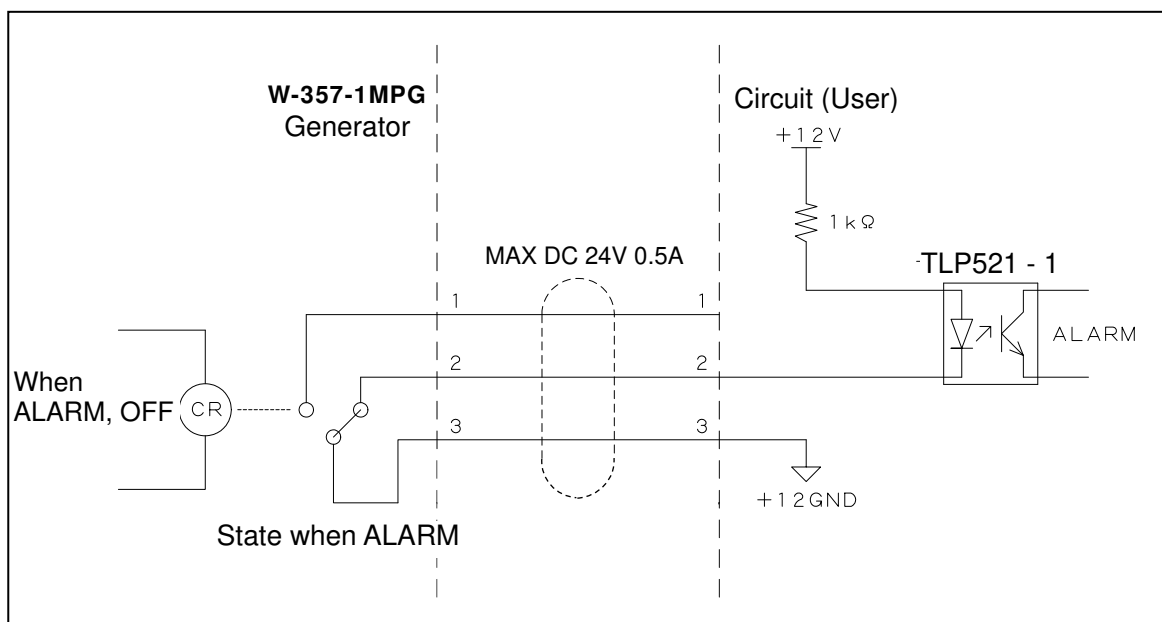

5-7. Connecting the 4-20mA cable

- ① To monitor the output power of the generator, connect the control cable to the 5-pin connector (provided) and connect the control cable to the ALARM/4-20mA connector (device (rear)). (Pins 4 -5 are used in 4-20mA.)
- ② Pin number

Pin 4	4-20mA Output +	RED line	→ User's circuit +
Pin 5	4-20mA Output -	WHITE line	→ User's circuit -

* Design the control circuit based on the conditions described in ① and ②.

5. Device Installation and Cable Connection

5-8. Connection to the RS-422A

To operate the device via Serial communication, connect the RS-422A interface to the external equipment (e.g., PC). The following describes the pin assignment of D-sub9 pin (male) of RS-422A connector.

Fig. 1. D-sub9 pin (Male) - Pin assignment

Pin No.	RS-422A (1)	RS-422A(2)
1	TXD	TXD
2	-TXD	-TXD
3	RXD	RXD
4	-RXD	-RXD
5
6
7
8
9	SHIELD (GND)	SHIELD (GND)

* Two D-sub9 pins are internally connected in parallel.

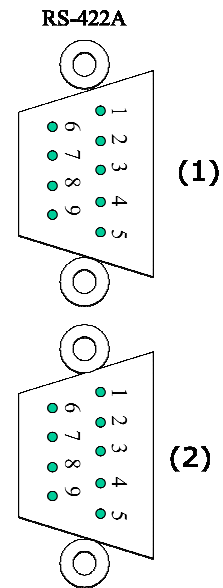

5-9. Connection to External Equipment (e.g., PC) - Example

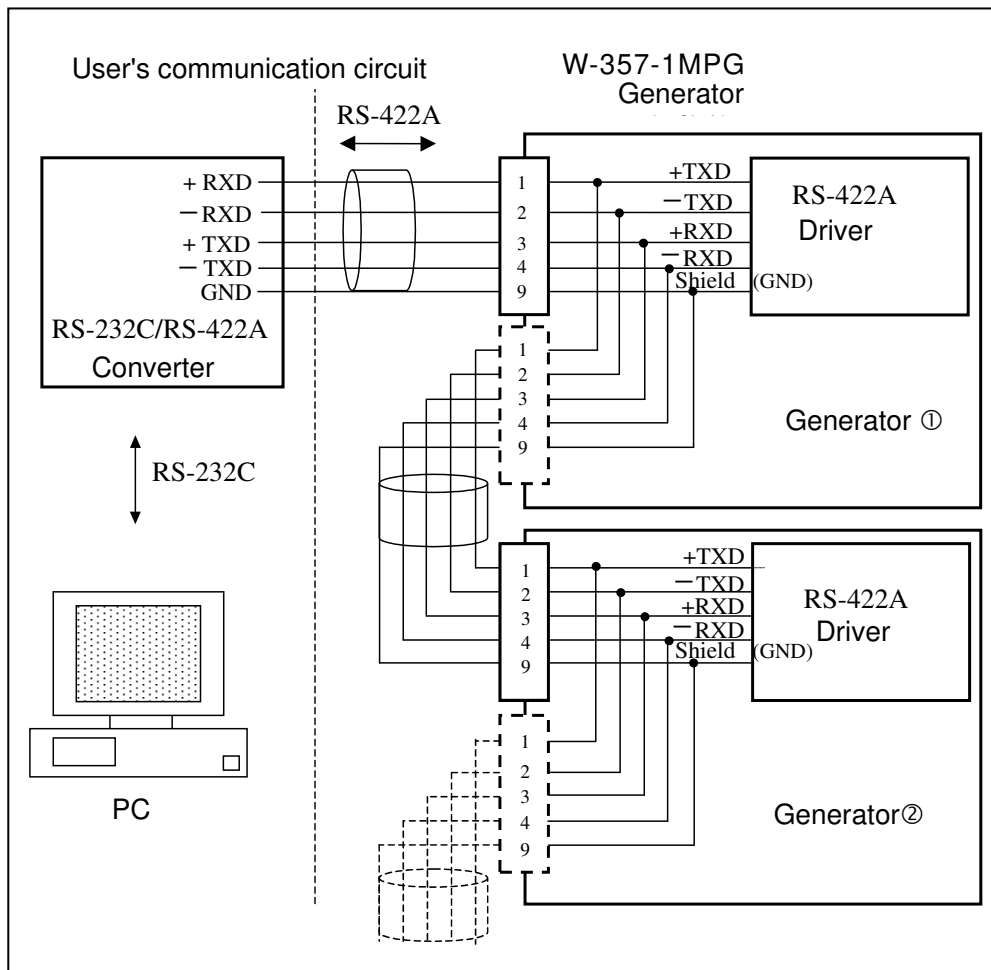

6. Installing the Device - Cautions

6. Installing the Device - Cautions

Caution - No Operation without water flow



- Water flow must be 0.9 L/min. (minimum)
 - * If you use the device with a water flow that is less than the minimum water flow, the water flow may not be provided onto the wetted surface of the transducer, or internal bubbles may not dissipate, causing no water oscillating. As a result, the element may be damaged. The minimum specified water flow is calculated for the standard joint (our product). If another type of joint is used, no water oscillating may occur, even if water flow more than the minimum is used. If you replace the joint, the device will not be covered by the warranty.

Caution - Starting the generator



- To prevent from no water oscillating, make sure to provide the water flow before starting the generator to dissipate the bubbles in the pipe and nozzle. Dissipate the bubbles for about 5 seconds after the water flow (more than the minimum water flow) is supplied to the nozzle tip and output from the nozzle.
 - * Make sure to check if there is the water flow.
 - * If the generator is started while the water is flowing and there are bubbles in the nozzle, no water oscillating occurs, damaging the transducer.
 - * You can dissipate the bubbles in the nozzle faster than by feeding the constant water flow, by feeding more water when you start the generator or turning the nozzle tip upward.

Caution - Stopping the generator



- Turn off the water flow after checking if the generator has stopped.

6. Installing the Device - Cautions

Caution - Installing the nozzle



- Install the nozzle so that the tip is angled 10° or more against the object to be cleaned. (See the figure below.) If you install the nozzle tip without an angle, the ultrasonic wave will reflect from the object to be cleaned. This means that the generator may not function correctly, or bubble dissipation will take a very long time. If you use the device in this state, the element may deteriorate or become damaged and cleaning inconsistencies may occur.

Installation Diagram

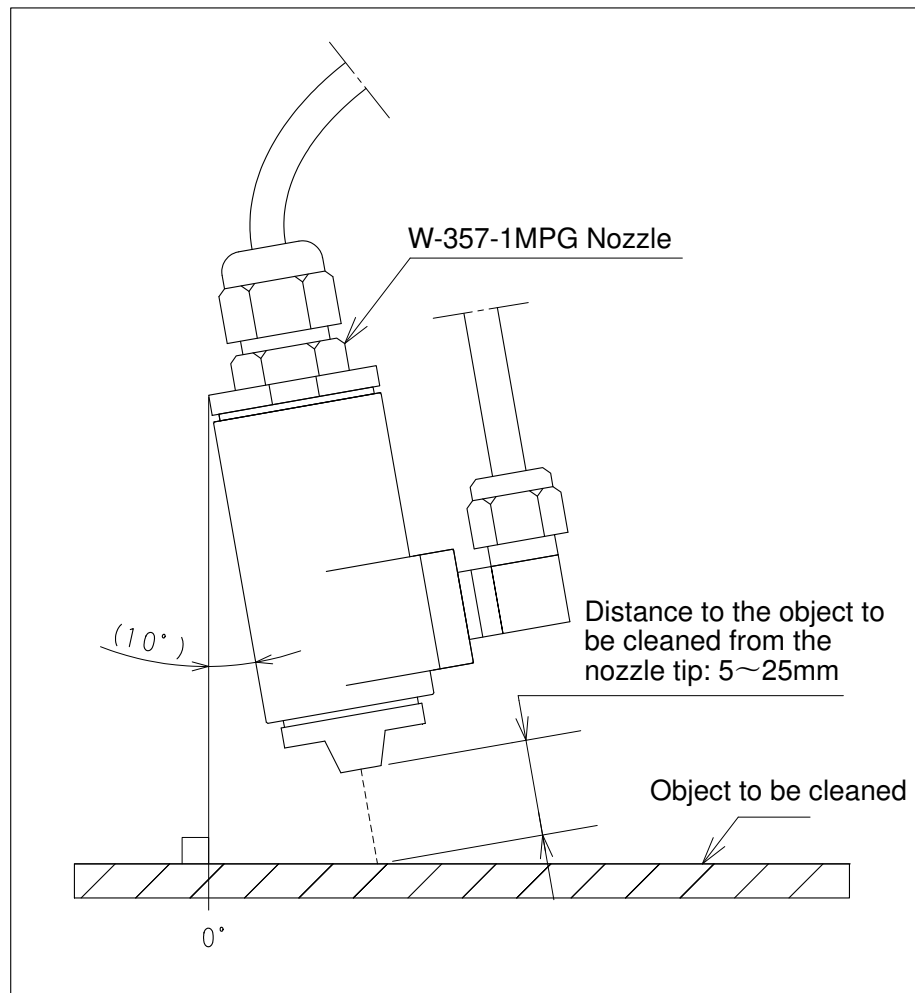

7. Operation

7. Operation

7-1. Caution

- ① The customer should provide a water flow switch that turns "ON" (CLOSE) the device when the water flow is 0.9 L/min. or more. (Contact capacity: 12V/18mA or more)
- ② Connect the control cable to the SENSOR connector and connect the RED/WHITE lines of the control cable to the contact of the water flow switch.



Do not touch the cleaning solution emitted from the nozzle tip while the ultrasonic waves are emitted,

7-2. Power ON

- ① Inject the cleaning solution for the specified water flow.
- ② When the device starts injecting the cleaning solution into the tank, wait until all bubbles in the pipe and the nozzle have been injected. The time required to dissipate the bubbles is about 5 seconds after when the cleaning solution of the specified amount is provided to the nozzle tip.



The bubbles dissipate differently depending on the pipe structure. If you run the generator, emitting ultrasonic waves, while the bubbles are in the pipe or nozzle, no water oscillating may occur and the transducer of the nozzle may be damaged. Make sure to start the generator after completely dissipating the bubbles.

- ③ Turn ON the power switch on the front panel.
- ④ After power has been provided to the generator, the LCD turns on and displays the opening message. The model name, software version, sub-CPU version is displayed.

W-357-1MPG

Main Ver 1.41
Sub-CPU 1.00

- ⑤ The main screen will appear in two or three seconds.

You can set the output power by INT (key input) or RS-422 (RS-422A). The mode that controls the output power is shown in the right corner of the screen, displaying

"INT" or "422". (See the next page.)

7. Operation

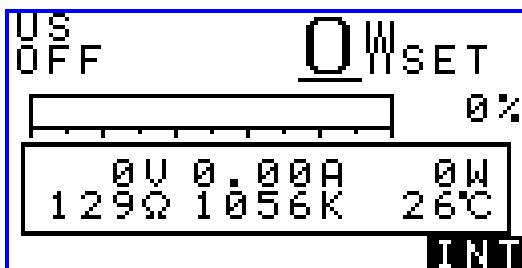

7-3. Setting

- ① You can change the mode in the MENU screen.

When you press the MENU key, the MENU screen appears. (You cannot change the mode while the generator is running.)

When you press the ESC key in the MENU screen, the previous screen appears.

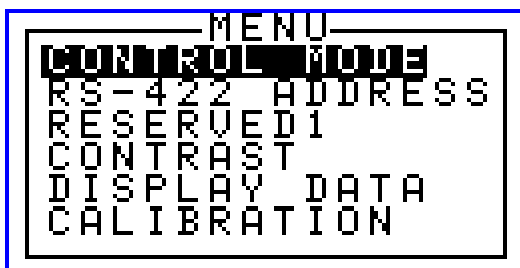

- ② Keys

△ , ▽ , ◀ , ▶ Select

MENU Go to the MENU screen, or Enter

ESC Cancel, or Go to the Previous screen

- ③ When you select "CONTROL MODE" and press the MENU key, the sub screen appears.

When you select the mode and press the MENU key, the mode changes.

When you press the ESC key, the input is cancelled and the previous screen appears.

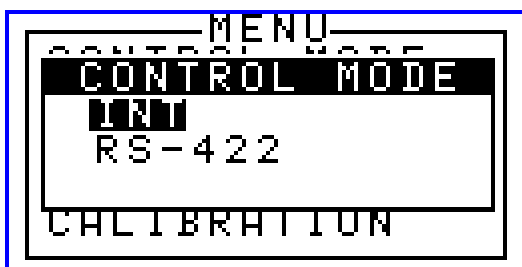

7. Operation

④ Selecting RS-422A

The Machine Address (ID) of RS-422A is displayed at the bottom of the screen.

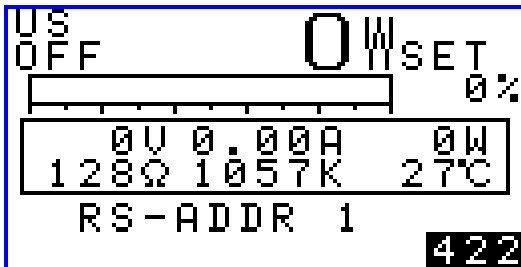

⑤ INIT mode - Changing the output power

When you press the ◀ or ▶ keys, the digit position ("Wset" number - Underlined) changes.

When you press the ▲ or ▼ keys, the numeral (underlined) is incremented or decremented.

You can change the output power while the generator is running.

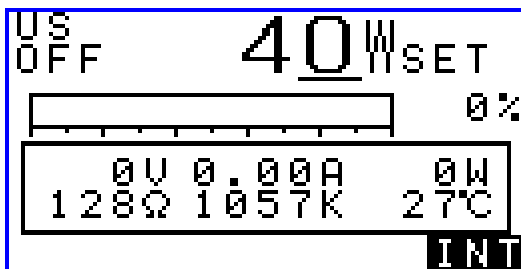

7. Operation

7-4. Oscillation

① Oscillation

REMOTE ON or SENSOR ON starts emitting ultrasonic waves.

REMOTE OFF stops emitting ultrasonic waves.

The box shows the measurement values.

From top left:

High-frequency voltage, High-frequency current, High-frequency power

Lower line:

Transducer impedance, Frequency, Heat sink temperature

The measured power is shown by the bar graph.

"Measure power / Set power x 100" is shown in %.

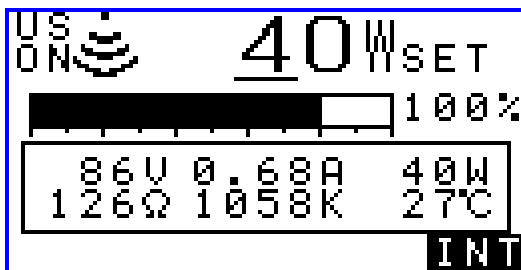

② SENSOR alarm

While the state is "REMOTE ON" and "SENSOR OFF", SENSOR alarm is output. The generator stops emitting the ultrasonic waves.

When the SENSOR is ON, the operation is resumed.

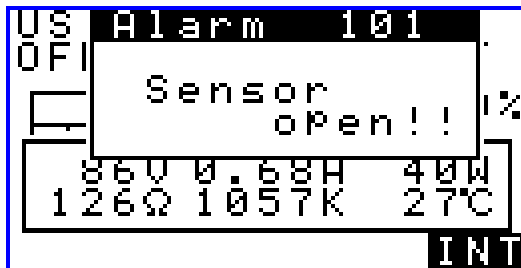

③ Other alarms

If an error occurs and the device cannot be operated correctly, an alarm is output.

If the output power and the measured power differ, the bar graph shows the difference with "hatching". The following page gives an example where the nozzle is not connected. This example shows that abnormally high impedance of the transducer and a 40W set power cannot be output.

The device will output an alarm and stop the generator.

Alarm 113 indicates the cause of the problem: the cable near the generator changed to "Open". The alarm is continuously displayed while the state is "REMOTE ON". If the cause of the problem is removed, you can turn REMOTE to ON (OFF → ON) to resume the operation.

* Alarm codes are listed in Appendix 1.

7. Operation

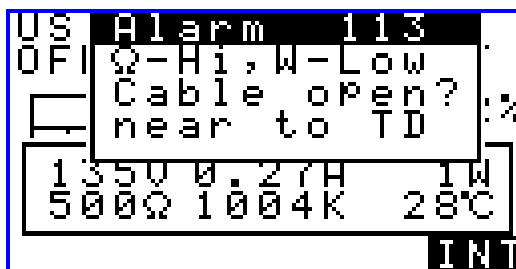
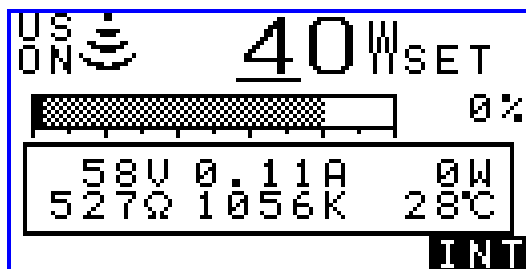

The generator, transducer and output cable have high voltage. Do not open the cover of the device. When you touch the device (e.g., connecting the cables), make sure to disconnect the power cable from the power source. If you don't disconnect the power cable, you may be killed or severely injured.

7-5. Shutting off the Power

- ① Turn OFF the power switch of the generator.
- ② Next, if you use any external driving devices, shut off the power of those devices.
- ③ Stop injecting the cleaning solution.

7-6. Detecting the Cleaning Solution

If there is no cleaning solution on the wetted surface of the transducer and if you continue operating the generator (emitting the ultrasonic waves), the transducer deteriorates and becomes damaged. As a result, you can connect the water flow switch to the SENSOR of the generator and you can stop the output if there is no water flow. However, if the pipe between the water flow switch and the nozzle fails, you may not be able to detect an insufficient water flow in the nozzle. To avoid this, you can detect the cleaning solution from the electrical state of the transducer. By doing so, you can protect the transducer from minor deterioration but it cannot be completely protected. If this kind of problem occurs, replace the nozzle, even though you can still perform the cleaning operation to a certain level.

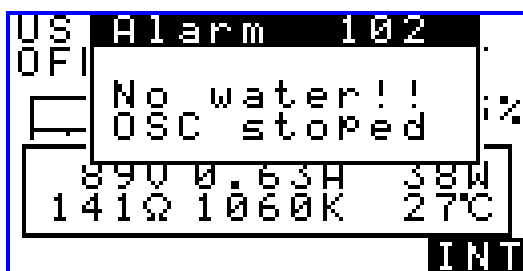

8. Effective Ultrasonic Cleaning - Hints

8. Effective Ultrasonic Cleaning - Hints

- ① Place the nozzle tip at a 5mm - 25mm location from the object to be cleaned. If it is placed further than 25mm, the ultrasonic effect decreases.
- ② Place the nozzle tip angled 10° or more against the object to be cleaned. If you install the nozzle tip without an angle, the ultrasonic wave reflects from the object to be cleaned. As a result, the oscillation becomes unstable, the element deterioration accelerates and the bubbles in the nozzle don't dissipate quickly, adversely affecting the cleaning result.
- ③ Place the nozzle so that the distance and angle between the nozzle tip and the object to be cleaned are constant. If the distance and angle are not constant, the sound pressure changes and causes inconsistent cleaning.
- ④ When the generator emits ultrasonic waves and if there is no enough water flow (more than the minimum), no water oscillating may occur. If there is too much water flow, the sound pressure of the ultrasonic wave may decrease. Use the generator with a water flow setting of 2.0 L/min or less.
- ⑤ During the cleaning operation, maintain constant liquid and ambient temperatures. If the liquid or ambient temperatures change, the sound pressure changes and causes inconsistent cleaning.



Caution

If the viscosity of the cleaning solution being used is not correct, the ultrasonic wave effect may decrease. If you use a cleaning solution with a lot of bubbles, no water oscillating may occur. These problems can cause a malfunction in the device.

9. MENU Operation

9. MENU Operation

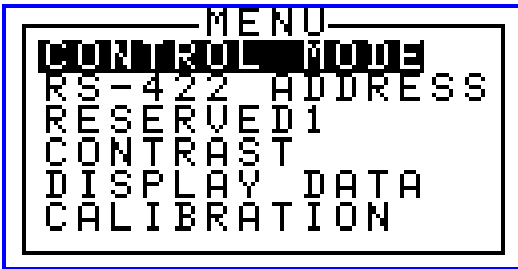

9-1. Keys

△ , ▽ , ◀ , ▶ Select

MENU Enter

ESCCancel, or Go to the Previous screen

9-2. CONTROL MODE

You can select the mode to set the output power.

INT (Key entry)

RS-422(RS-422A)



9-3. RS - 422 ADDRESS

You can set the Machine Address (ID) when RS-422A is used.

You can use any of the following letters for the ID:

0-9, A, B, C, D, E

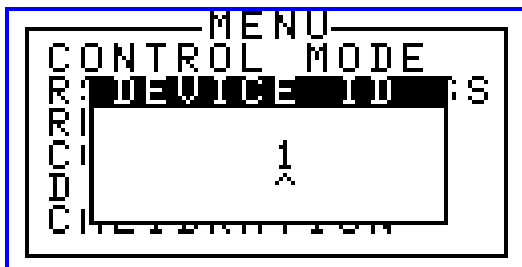

9. MENU Operation

9-4. RESERVE1

This is a parameter for function extension.

It is set as "0" in the standard specification.

9-5. CONTRAST

You can change the contrast level of the LCD display panel.

9-6. DISPLAY DATA

- ① **Osc**: Cumulative time (Hour:Minute:Second) that the generator outputs the ultrasonic waves (This cannot be cleared to "0".)
- ② **Td**: Cumulative time that the transducer is used. You can select "0 Clear" when you calibrate the device.
- ③ **Cal**: Cumulative time that the generator outputs the ultrasonic waves after calibration.
- ④ **Times**: Number of times that the generator outputs ultrasonic waves. This is the same as the number of times of "REMOTE ON/OFF".
- ⑤ **Freq**: Driving frequency of the transducer. This is the moving average of the frequency being tracked.
- ⑥ **Impe**: Transducer's impedance. This is the moving average of the transducer being tracked.

These data items are only displayed.

DATA	DISP
Osc	233:02:18
Td	233:02:18
Cal	29:22:36
Times	73836
Freq[kHz]	1048
Impe[Ω]	104

9-7. CALIBRATION

① Calibration

When you replace the transducer (nozzle) with a transducer and a cable with identical specifications, you don't need to calibrate the device. However, to ensure an optimal margin, the device has an automatic calibration function. Also, a parameter that detects the cleaning solution is recorded at this time. This process is called a calibration. The calibration should be done if the specification (e.g., cable length) changes. Note: When the device performs the calibration, the device shows much data. This data is displayed to help us troubleshoot problems. (The data is not described here.)

9. MENU Operation

② Checking the cleaning solution

Select "CALIBRATION" in the MENU screen. Press the MENU key. The following screen appears.

Verify that the cleaning solution flows 0.9 L/min or more. If there are no problems, press the MENU key.

To cancel the operation and return to the previous screen, press the ESC key.

```
CALIBRATION
Please confirm
to water flow

OK- MENU key
NG- ESC key
```

③ Performing the calibration

Wait 2 to 3 minutes until the buzzer is output.

```
US  CAL Step 2
ON Search FaFr
████████████████████ 63Ω
12V 0.19A 3W
63Ω 1002K 21°C
Fa k Ω
Fr k Ω
```

```
US  CAL Step 4
ON Tuning Fa
████████████████████ 75Ω
18V 0.24A 4W
75Ω 1125K 19°C
Fa 1086k 136Ω
Fr 978k 60Ω
```

④ Terminating the calibration

Press the ESC key.

```
US  CAL Complet
OFF Push ESC key
████████████████████ 129Ω
61V 0.47A 160
129Ω 1058K 350vc
Fa 1086k 136Ω 1035
Fr 978k 60Ω 1091
```

9. MENU Operation

⑤ Displaying the impedance characteristics

Simple impedance characteristics are displayed.

The X-axis shows the frequency. The Y-axis shows the impedance.

If the state is normal, you can see the turning point and the peak.

Press the ESC key to go to next.

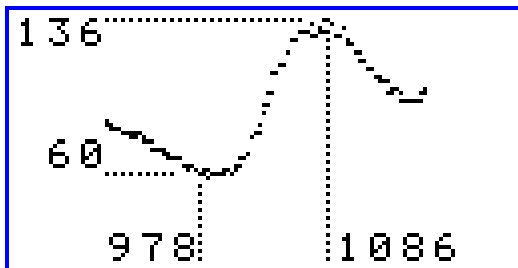

⑥ COUNTER CLEAR

If you replace the nozzle (transducer) when the device is calibrated, Td (Cumulative time) is cleared to "0".

If the nozzle is replaced, press the MENU key.

If the nozzle is not replaced, press the ESC key.

```
COUNTER CLEAR
Did you change
new transducer?
YES- MENU key
NO-  ESC  key
```

⑦ When you complete the above steps, turn the generator power off and then turn it on again. Select "DISPLAY DATA" in the MENU screen and verify that the cumulative time of "Td" and "Cal" has been reset to "0:00:00".

- * If you started the generator before verifying the cumulative time, the time may be forwarded from "0:00:00".
- * If you press the ESC key unintentionally, Td (Cumulative time) is not cleared to "0".
- * If an alarm is output during calibration, check if the cable is correctly connected and the water flow is the specified value. Perform the calibration again. If an alarm is still output, contact your dealer.

10. RS-422A

10. RS-422A

10-1. RS-422A Specification

Electrical characteristics	EIA RS-422 compliant
Communication method	Half-duplex
Synchronization scheme	Asynchronous
Transmission rate	9600 bps
Start bit	1 bit
Data length	7 bit
Parity	Even parity
Stop bit	1 bit
Delimiter	CR
Character code	ASCII code
Machine address (ID)	0 - E
Error check	BCC (Even horizontal parity)



For details on pin assignment, see "5-8 Pin assignment" (Page 14).

10. RS-422A

10-2. Communication Commands and Responses

Communication command	Send	Response
Output power setting W command	"I[ID],W[Power: 3 digits]W, [BCCH], [BCCL], [CR]" * Power: Set in the range [000~040] Only 422 mode is valid.	"I[ID], W[Power: 3 digits]W, [BCCH], [BCCL], [CR]"
Read status STA command	"I[ID], STA, [BCCH], [BCCL], [CR]" * Any mode is valid.	"I[ID], M[Measured power: 3 digits]W, Rx, Ex, Sx, Wx, [BCCH],[BCCL],[CR]" Rx-REMOTE state [x=0: Open / =1: Short] Ex-Mode state [x=0:INTorNET / =1:RS-422] Sx-SENSOR state[x=0: Open / =1: Short] Wx-Power Control state x=0: Normal power x=1: Higher than alarm threshold x=2: Alarm threshold or lower
Software version VER command	"I[ID], VER, [BCCH], [BCCL], [CR]"	"I[ID],VERxxxx,[BCCH],[BCCL], [CR]" xxxx: Version (e.g., 1.00)
Output power setting A command (For current models)	"I[ID], A[Current: 4 digits]A, [BCCH], [BCCL], [CR]" * Current: Set in the range [0.00~0.70] Power=40 / 0.49 x Current x Current (Conversion) Only 422 mode is valid.	"I[ID], A[Current]A ,[BCCH], [BCCL],[CR]" *Current: Conversion (value) from the power
Read status STATE command (For current models)	"I[ID],STATE,[BCCH],[BCCL],[CR]" * Any mode is valid.	"I[ID], M[Measured power: 3 digits]A, Rx, Ex, Sx, Cx, [BCCH], [BCCL], [CR]" Rx,Ex,Sx: Same as STA command Cx: Same as Wx (STA command)

[ID] ... Machine address (0 - E)

[BCCH]... 0 - F (Even horizontal parity - Upper 4 bits)

[BCCL] ... 0 - F (Even horizontal parity - Lower 4 bits)

[CR] ... 0D(Hex)

- The response to the SEND command delays for 600ms immediately after a REMOTE short.
- While the generator is running (emitting ultrasonic waves), the response for the output power setting delays for 600ms.

10. RS-422A

10-3. Error response

If an error occurs after [CR], an error response is returned.

Example) “[ID],COMERR,[BCCH],[BCCL],[CR]”

- If the set value is out of scope, NUMERR is returned. (Only W and A commands (Output setting command))

Error response

Error command (#2)	Description	Priority in error contention
PARERR	Parity error	1
FRMERR	Framing error	2
OVRERR	Overrun error	3
COMERR	Command error	4
NUMERR	Numerical error	5
BCCERR	BCC error	6

	<ul style="list-style-type: none"> ▪ If a command error occurs and the set power (current) value is out of scope, the device maintains the state before the data was entered. ▪ If the ID (Communication) and Generator ID do not match, no response is returned.
---	---

10-4. SEND and Response

① Output power setting - Example: ID = 1 / Set power value = 40W

SEND command	Response
“I1,W040W,4,C,[CR]”	⇒ “I1,W040W,4,C,[CR]”

② State read result - Example: ID = 1 / Set power value = 40W

SEND command	Response
“I1,STA,3,E,[CR]”	⇒ “I1,M040W,R1,E1,S1,W0,4,4,[CR]”

11. Generator - Outline View

11. Generator - Outline View

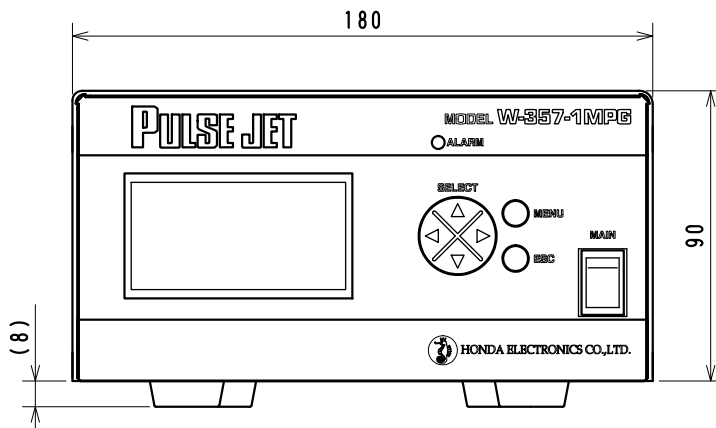
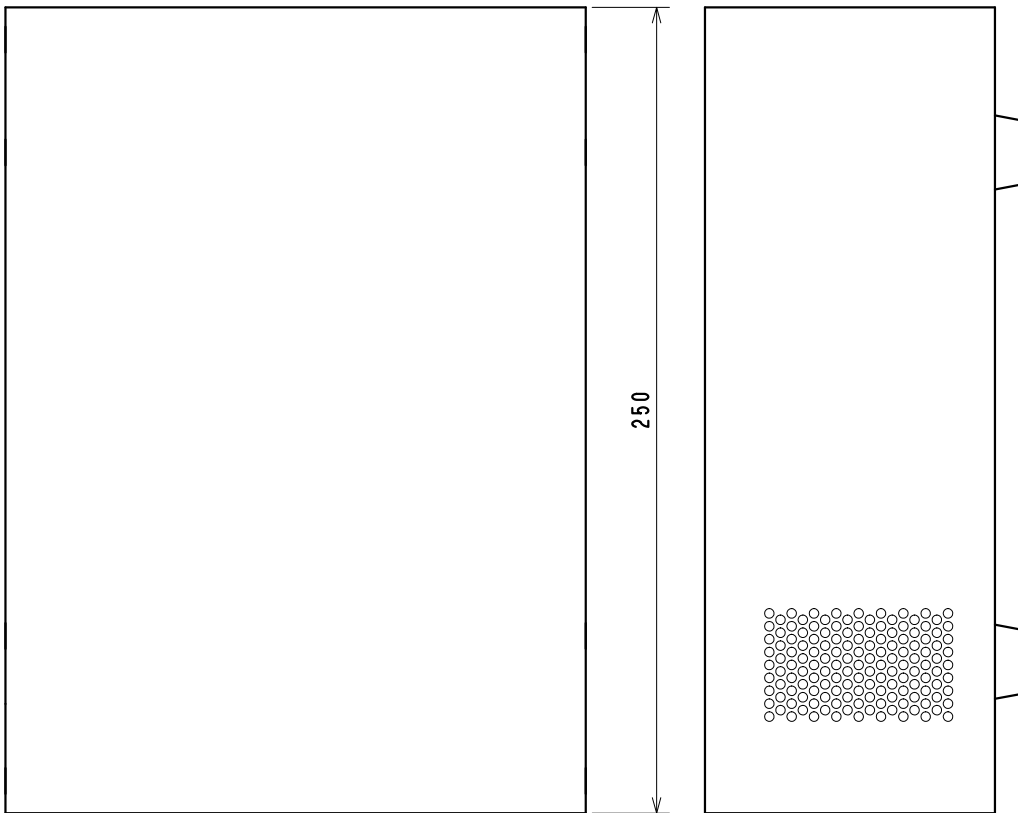
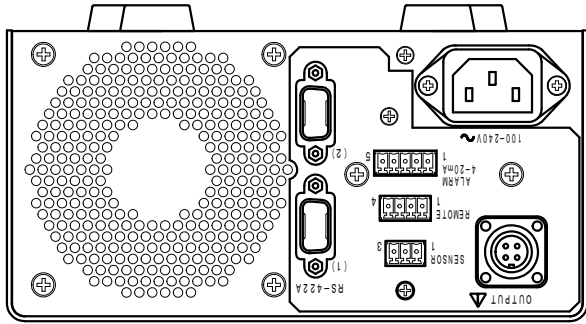

12. Nozzle - Outline View

12. Nozzle - Outline View

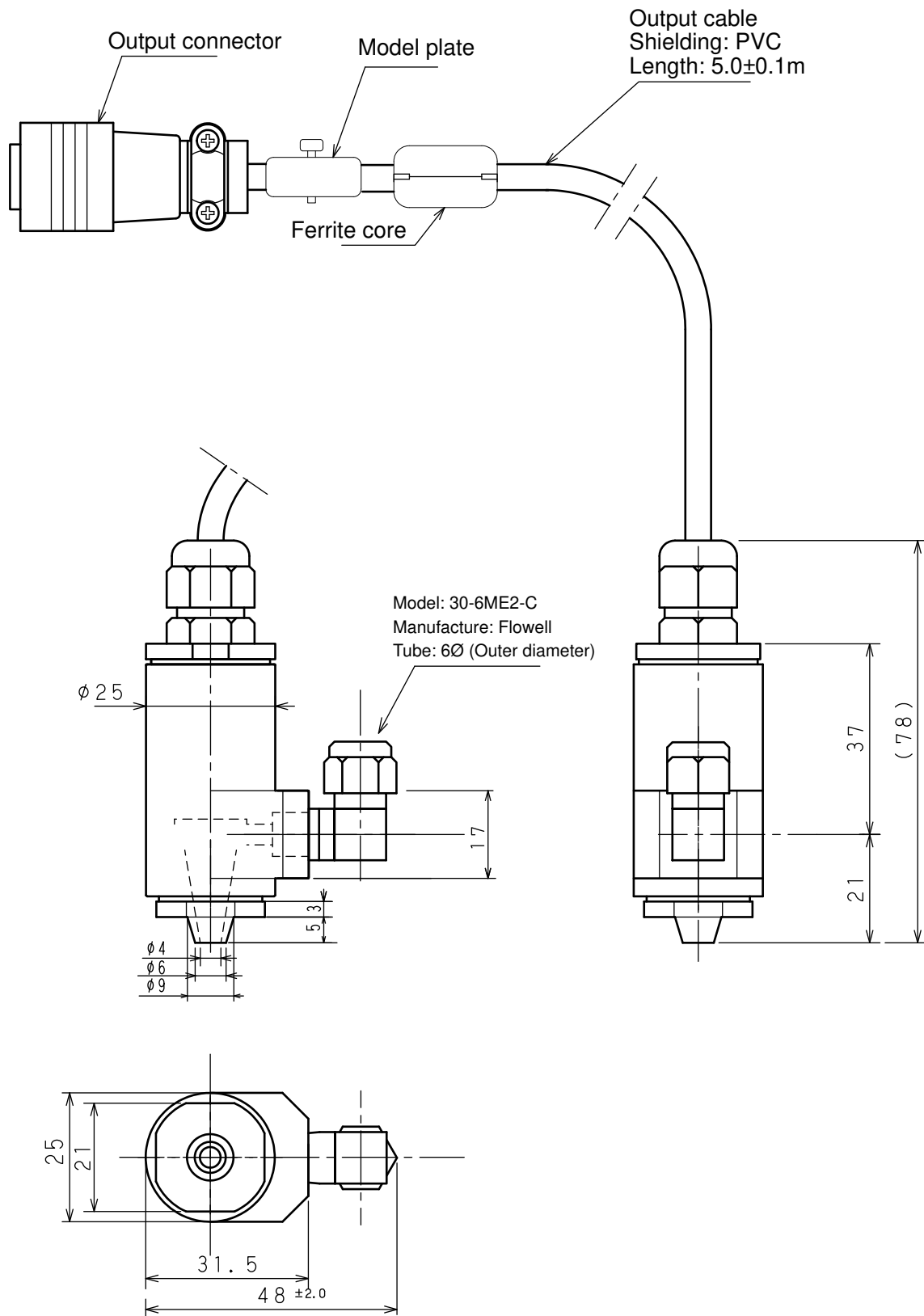

13. Cable (provided) - Outline View

13. Cable (provided) - Outline View

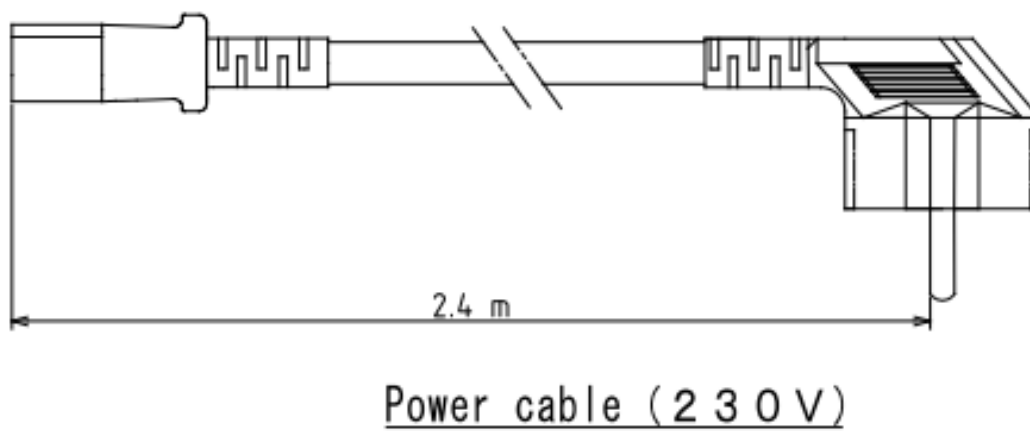
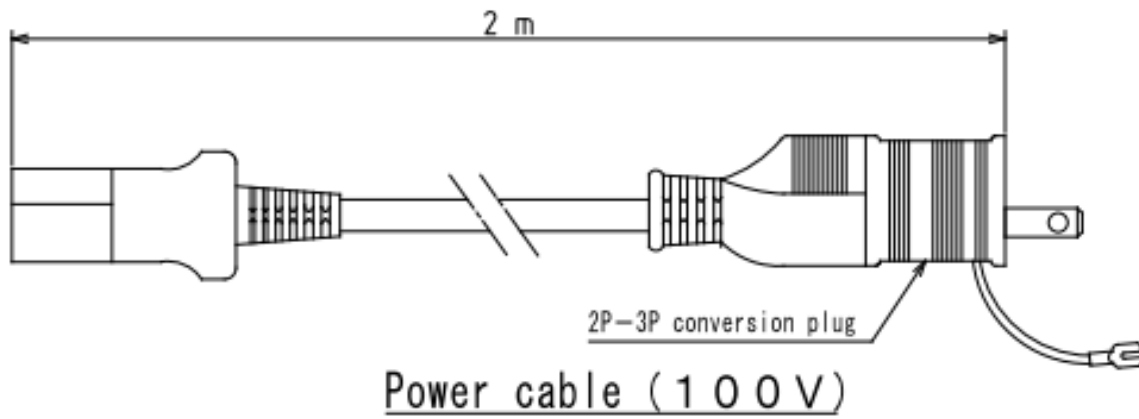
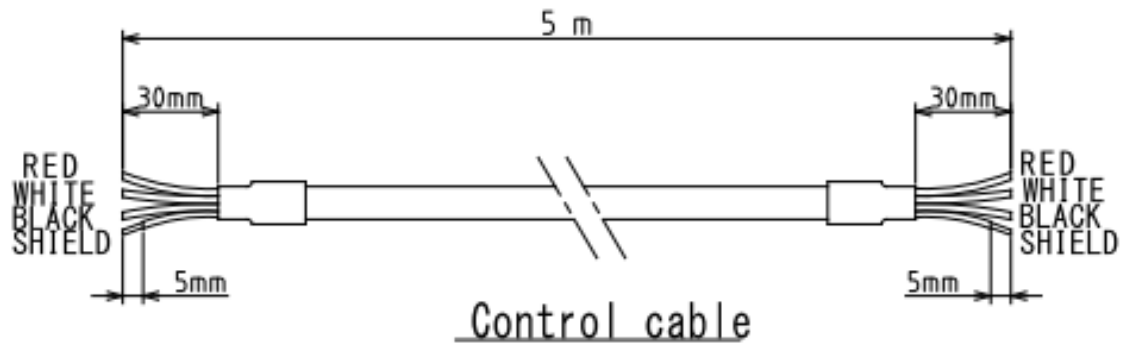

14. Generator - Connection Diagram

14. Generator - Connection Diagram

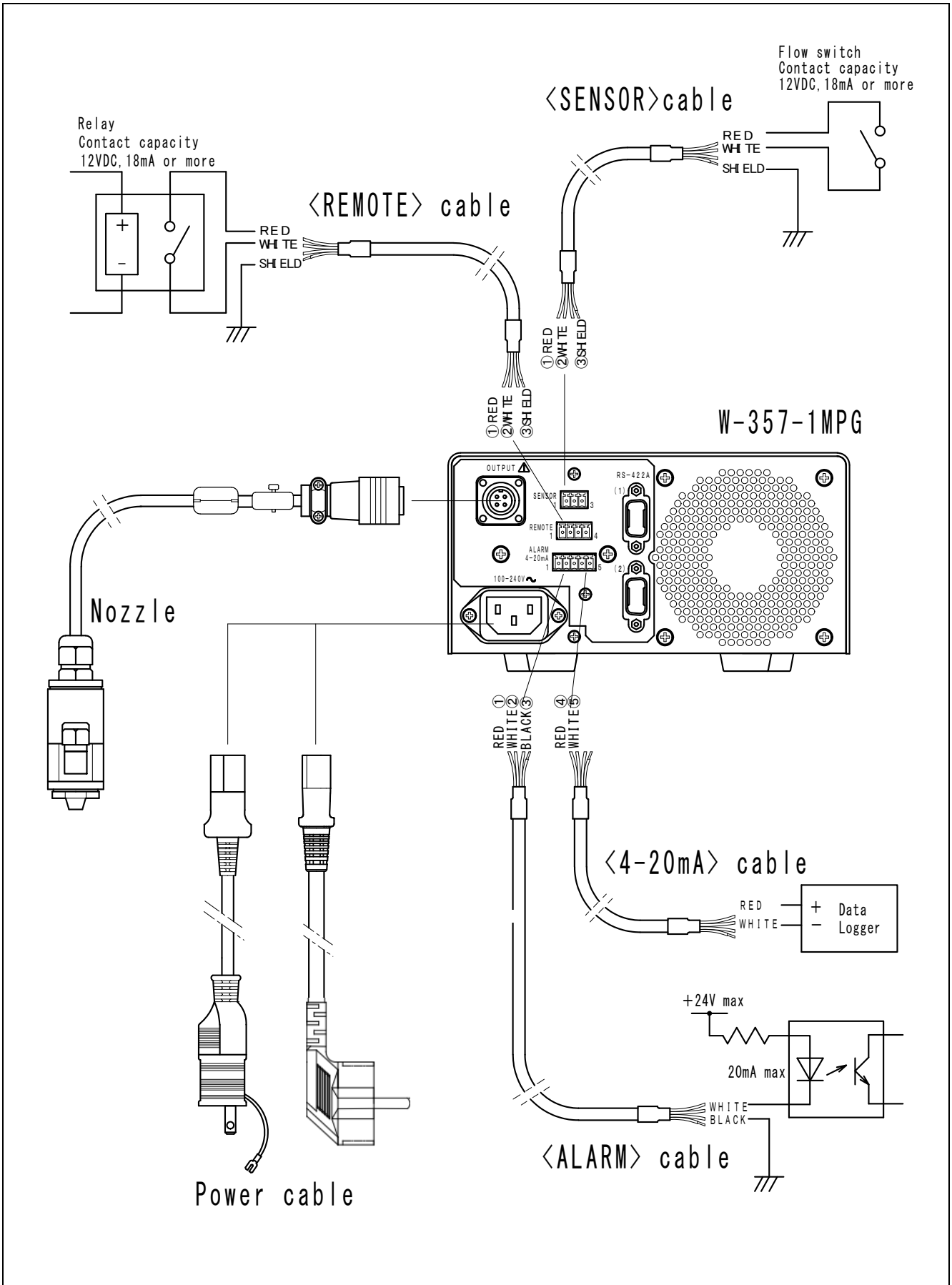

15. Product Specifications

15. Product Specifications

• Generator

1. Model W-357-1MPG
2. Oscillation method Transducer phase synchronization oscillation method
3. Oscillation frequency 1MHz (Nominal)
4. Output range 0~40W
5. Output adjustment Constant power control
Set by key entry or RS-422A.
6. Power Nominal voltage - Single phase 100V - 240V AC
50/60Hz, 300VA
Fuse: 5A (User cannot replace the fuse)
7. Error detection Output cable - Short, Open
Transducer impedance error
Overcurrent, Abnormal power
Dry boiling error
Flow sensor OFF
8. Interface
 - (1) Sensor input Connector: MCV1,5/3-G-3,5 (Manufacturer: PHOENIX CONTACT)
Flow rate sensor - Close = Flow rate OK
 - (2) Remote input Connector: MCV1,5/4-G-3,5 (Manufacturer: PHOENIX CONTACT)
Close = Oscillation ON
 - (3) Alarm output /4-20mA output Connector: MCV1,5/5-G-3,5 (Manufacturer: PHOENIX CONTACT)
 - Alarm output
Relay contact output when alarm is output
Both A and B contacts: Output
Rated load: DC24V / 0.5A
Alarm LED: RED
 - 4-20mA output
Connector: MCV1,5/5-G-3,5 (Manufacturer: PHOENIX CONTACT)
Measured output power is output.

15. Product Specifications

- | | | | | | | | | | |
|---------------------------|---|--------------|--|--------------|--|------------------|---|---------------------------|---|
| (4) RS-422A | Connector: Dsub-9pin(M) - 2 units: Parallel connection
9600bps, 7bit, Stop1bit, Even parity, BCC
Machine Address (ID): 0 - E (Set in MENU screen)
Output power setting, Status read | | | | | | | | |
| (5) LCD | <table border="0" style="width: 100%;"> <tr> <td style="width: 15%;">MENU setting</td> <td>Control Mode setting
RS-422A - Machine number setting
LCD contrast setting</td> </tr> <tr> <td>MENU display</td> <td>Oscillation cumulative time
Cumulative time after transducer replacement
Cumulative time after calibration
Number of oscillations
Frequency (calibration)
Impedance</td> </tr> <tr> <td>MENU calibration</td> <td>Optimal oscillation frequency
Optimal tracking range setting
Measurement result saving (e.g., Impedance)
Impedance characteristics display</td> </tr> <tr> <td>Oscillation state monitor</td> <td>Output power, High-frequency voltage,
High-frequency current, Transducer impedance,
Oscillation frequency, Heat sink temperature,
Oscillation ON/OFF, Set power.
Alarm number display</td> </tr> </table> | MENU setting | Control Mode setting
RS-422A - Machine number setting
LCD contrast setting | MENU display | Oscillation cumulative time
Cumulative time after transducer replacement
Cumulative time after calibration
Number of oscillations
Frequency (calibration)
Impedance | MENU calibration | Optimal oscillation frequency
Optimal tracking range setting
Measurement result saving (e.g., Impedance)
Impedance characteristics display | Oscillation state monitor | Output power, High-frequency voltage,
High-frequency current, Transducer impedance,
Oscillation frequency, Heat sink temperature,
Oscillation ON/OFF, Set power.
Alarm number display |
| MENU setting | Control Mode setting
RS-422A - Machine number setting
LCD contrast setting | | | | | | | | |
| MENU display | Oscillation cumulative time
Cumulative time after transducer replacement
Cumulative time after calibration
Number of oscillations
Frequency (calibration)
Impedance | | | | | | | | |
| MENU calibration | Optimal oscillation frequency
Optimal tracking range setting
Measurement result saving (e.g., Impedance)
Impedance characteristics display | | | | | | | | |
| Oscillation state monitor | Output power, High-frequency voltage,
High-frequency current, Transducer impedance,
Oscillation frequency, Heat sink temperature,
Oscillation ON/OFF, Set power.
Alarm number display | | | | | | | | |
| (6) Key entry | △ , ▽ , ◁ , ▷ , MENU , ESC | | | | | | | | |
| 9. Usage environment | Temperature: 5 - 40°C / Humidity: 10 - 85%
Indoor usage in industrial environment
Altitude: 2000m or lower (Pollution level: 2 / Overvoltage category: II) | | | | | | | | |
| 10. External dimensions | 180(W) × 250(D) × 100(H)mm (Including rubber feet) | | | | | | | | |
| 11. Weight | 2.2kg | | | | | | | | |

15. Product Specifications

● Nozzle

1.	Maximum input	40W
2.	Material	
	Main unit (except nozzle tip) Nozzle tip Cap cone Transducer Vibrating plate Packing (Wetted part)	PCTFE PTFE PVDF PZT Special ceramics Perfluro PCTFE, PTFE, Special ceramics, Perfluro
3.	Water flow (Flow rate ejected from the nozzle tip / Liquid temperature: 20~50°C)	0.9 (L/min) or more (Straight type joint is used - Same)
4.	Solution feeder	Rc (Taper) - Female screw 1/8 Elbow type joint: 30-6ME2-C (Manufacturer: Flowwell)
5.	Solution supply	Tube size: External diameter 6mm
6.	External dimensions	21.5 × 25 × 80mm (Not including the joint)
7.	Weight	300g
8.	Output cable	
	Bending resistance cable Length Shield material	5m PVC

● Accessories

1. Control cable 5m : 4 cables

(Connected to SENSOR, REMOTE, ALARM, 4-20mA)

* The RS-422A cable is not provided.

2. Connector for control cable (3-pin, 4-pin, 5-pin) : 1 pc/ each

16. Precautions in Using the Device

16. Precautions in Using the Device

The following describes the precautions to use with this product.

(1) Combination

You can calibrate the Generator (W-357-1MPG - standard specification) and the nozzle. You may not calibrate a product that is custom made (special specification). Contact your dealer if needed. Calibrating a custom-made product (special specification) may cause a malfunction or accident.

(2) Shock

Do not subject the product to shock. When you install, move or store the product, make sure not to hit or drop it. (In particular, handle the nozzle carefully because the nozzle is fragile.)

(3) Output cable

The output cable is connected to the nozzle to connect the nozzle to the generator. Do not alter the cable length or the connector. Altering the cable length or connector may cause a malfunction or an accident.

(4) Nozzle joint

A joint that supplies the cleaning solution is attached to the nozzle. Do not alter the joint. Altering the joint may cause dry boiling or solution leakage.

(5) No water oscillating

This product has a "SENSOR" contact to prevent from no water oscillating. Make sure to connect the water flow switch and SENSOR contact so that the switch turns ON (CLOSE) when water more than the specified amount flows.

(6) Installation

Do not block the generator vent. The vent is used to dissipate heat from the generator. If you use the generator when the vent is blocked or in an environment where environment usage conditions (temperature, humidity) have not been satisfied, the generator may malfunction. Make sure to install the device in the correct environment.

(7) Storage

Store this product in a location:

- Not subject to direct sunlight
- Temperature: -15°C - +60°C
- Humidity: 10 - 85%
- No condensation

(8) Cleaning

Use an appropriate cleaning cloth to clean the generator or nozzle. Wipe the generator or nozzle if needed.

Appendix 1: Alarm code list (W-357-1MPG)

No	Alarm	Description
10	Backup data error	Abnormal backup data
20	Low frequency	The frequency is lower than the lower limit when the frequency is automatically set.
21	High frequency	The frequency is higher than the upper limit when the frequency is automatically set.
98	Overpower detected	Power 50% higher than the set current is detected.
99	Overcurrent detected	Current exceeding the maximum allowed current of the design is detected.
101	Insufficient cleaning solution flow	The SENSOR cable is not shorted.
102	Water detection	The impedance is larger for the specified amount than the average value.
110	Power small	The power is more than 5W lower than the power set by the device or communication.
111	Power small - Impedance small	The power is more than 5W lower than the power set by the device or communication and the impedance is lower more than the specified value than the average value.
112	Power small - Impedance large	The power is more than 5W than lower than the power set by the device or communication and the impedance is larger more than the specified value than the average value.
113	Power small - Impedance large	The power is more than 5W lower than the power set by the device or communication and the impedance is larger more than the specified value than the average value.
120	Power large	The power is more than 5W larger than the power set by the device or communication.
121	Power large - Impedance small	The power is more than 5W larger than the power set by the device or communication and the impedance is smaller more than the specified value than the average value.
122	Power large - Impedance large	The power is more than 5W larger than the power set by the device or communication and the impedance is larger more than the specified value than the average value.

The alarm codes listed above are used in 1MPG (Standard product).
Some alarms are disabled for a custom made product (special specification).

- Oscillation behavior when an alarm is output
 - The main unit (1MPG) turns on the alarm LED and stops the oscillation. The alarm details are output as "Alarm No." in the display and communication.*1
 - You can cancel the alarm state by turning OFF the REMOTE signal of the main unit and then turning ON the signal again. (The REMOTE signal is controlled by the sequencer.)

*2 *3 *4

- "Alarm No. 99" (Overcurrent detected) completely terminates the oscillation to protect the generator. You cannot cancel this alarm by turning OFF/ON the REMOTE signal. If "Alarm No.99" occurs, turn OFF/ON the generator power to cancel the alarm.
 - If the alarm is not cancelled even after cancelling the alarm multiple times, the device may have failed. Contact your dealer for repairs.
-

- *1 Only "Alarm No. 20" and "Alarm No. 21". The alarm LED does not turn on. The oscillation is stopped and the Alarm No. is displayed in the same way as other alarms.
- *2 "Alarm No. 10" indicates a failure in the electrical circuit. Contact your dealer for repairing the device.
- *3 "Alarm No. 102" indicates a failure in the transducer. Contact your dealer for repairing the device.
- *4 "Alarm No. 112" and "Alarm No. 113" can be output even if the output cable or relay cable is not connected. Check if the output cable or relay cable is correctly connected.

◆ **After sales service**

When the after service such as the repair is required, please contact the seller of product with the detailed information about the malfunction.

Do Not Duplicate

W-357-1MPG



HONDA ELECTRONICS CO.,LTD.

Industrial Equipment Division

20 Oyamazuka, Oiwa-cho, Toyohashi, Aichi 441-3193, Japan

TEL : +81-532-41-2774 FAX : +81-532-41-2923

URL: <http://www.honda-el.net/>

- **This instruction manual is as of 2024 March.**
- **The specifications for the product may be changed without prior notice to improve the product.**

MADE IN JAPAN
2024.03