

YASKAWA

MV1000

MEDIUM VOLTAGE AC DRIVE



Yaskawa is the leading global manufacturer of high quality low and medium voltage variable frequency drives, servo systems, machine controllers and industrial robots.

WE ARE YASKAWA.



Our standard products, as well as our tailor-made solutions, are well known for their outstanding quality and reliability.

More specifically, we are the drive, motion and robotic specialists that can be the difference between your business success and failure, the advancement of your operational efficiencies from very good to exceptional.

Nearly 1,000 associates in four countries at 11 locations in the Americas.

More than 150 distributor partners. 170 ASPs. And 190 service centers. All ready to serve you. That's Yaskawa.

DRIVES

Yaskawa is committed to keeping your operations up and running with the highest quality, most reliable variable frequency drives in the world. We know drives. We are the leaders in their innovation, experts in their application, and unsurpassed in the customer service that supports them.

MOTION

Yaskawa delivers motion-centric solutions to OEMs and end-users that push the boundaries of machine performance and increase overall equipment efficiencies. We do this by leveraging our servo and machine controller technology in ways that help customers embrace and solve their toughest challenges.

ROBOTICS

Yaskawa Motoman develops revolutionary robotic technologies that deliver transformative results in precision, productivity and performance. We do this in packaging, arc welding, assembly, coating, material cutting and dispensing. In many ways, we are the robotics experts.

QUALITY & RELIABILITY



Delivering quality at Yaskawa goes beyond providing you with the most robust and reliable products available. Quality is about providing you with the best total experience when working with us.

Whether it's quoting or ordering, on-time delivery, ready access to technical support and customer service, or just enhancing your overall efficiency, we want you to have a quality experience in every step of our relationship.

COMMITTED TO THE FUTURE

Medium voltage (MV) Drives offer energy savings with improved process control. The MV1000 provides these features and then leapfrogs the industry with outstanding reliability, support, harmonic performance, and state-of-the-art features.

Building on past success, the MV1000 minimizes application and installation challenges, by providing:

- Industry Leading Low Input Current Harmonics (iTHD)
- Multi-phase Input Transformer with Galvanic Isolation
- Near Sinusoidal Output Waveform
- Proven Reliability with High Performance
- Compact and User Friendly
- Dedicated, Local Support
- Compatibility with Yaskawa A1000 LV Products



The MV1000 offers high performance and proven Yaskawa reliability. Based on the A1000 control platform, application flexibility is assured. Yaskawa's proven QC/QA processes offer the highest reliability in the MV drive industry.

25+ YEARS OF MV SUCCESS

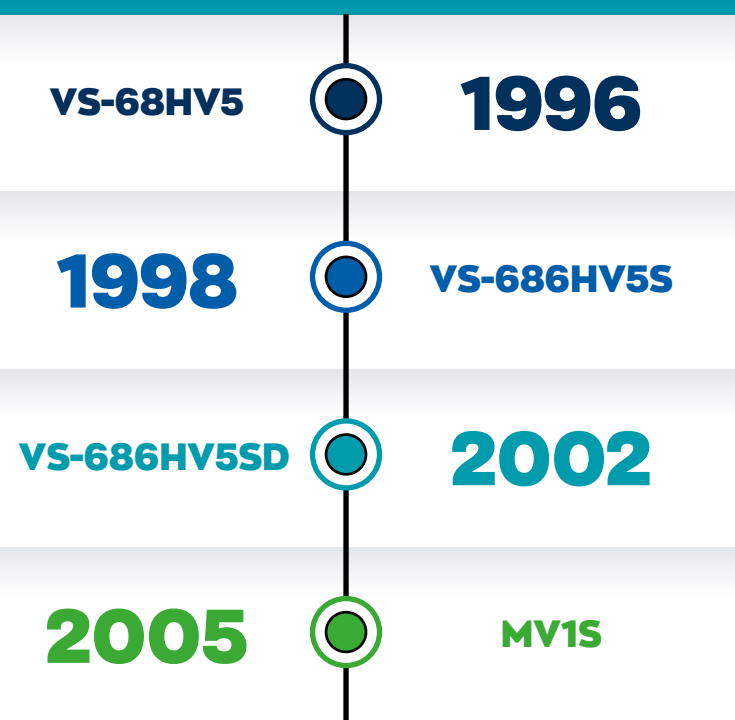

MV1000

Since 2013



POWER SYSTEM FRIENDLY

- Exceeds IEEE 519 harmonic distortion requirements
- 36-Pulse input transformer exceeds industry requirements
- Transformer provides isolation and makes the drive insensitive to power line quality issues

PROVEN RELIABILITY

- Yaskawa's superior design and quality control provides unmatched industry reliability
- 20+ Year design life
- Highest MTBF = Lowest life-cycle cost (LCC)
- Conformal coated circuit boards

USER FRIENDLY

- Intuitive operation and maintenance
- Programming is the same as Yaskawa low voltage drives
- DriveWizard MV for programming, monitoring, trending, and troubleshooting

MOTOR FRIENDLY

- 17-level motor waveform
- Minimizes harmful dV/dt

COMPACT DESIGN

- Optimal packaging and shipping splits facilitate ease of transportation, installation, and maintenance

GLOBAL STANDARD

- Conforms with UL, CSA, IEEE 519 and other global standards

PROVEN RELIABILITY

Designed, Developed, and Manufactured using Yaskawa's world renowned quality and reliability standards.

Yaskawa's MV1000 builds on the previous generation MV Drives success using the same rigorous design rules and Quality Control/Quality Assurance (QC/QA) practices.

The MV1000 leads the industry with a MTBF of greater than 200,000 hours. This leads to an expected drive lifetime of greater than 20 years.



PRODUCT LIFETIME OF OVER 20 YEARS

Industry Leading Quality and Reliability

W. EDWARDS DEMING PRIZE

Yaskawa Electric Corporation, the parent company of Yaskawa America, is the proud recipient of the W. Edward Deming Prize. We remain the only company in the world, in our industry, to have earned this high distinction.



IMPORTANCE

Yaskawa has taken the intensive steps necessary to incorporate a standard of quality into its world class manufacturing facilities that cannot be found anywhere else. It proves you can trust us to deliver products that will perform, people that will respond and the results you need from your automation systems.



DESIGN CONSIDERATIONS

Every component is selected to go above and beyond industry requirements to ensure product longevity.

Yaskawa's patented transformer uses no exposed conductors, lightning arrestors, double creepage clearances, and a 45 kV BIL for 4 kV primary (industry standard is >30 kV).

Each of these requirements and more lead to the MV1000's 20+ year product lifetime.

COMPUTER AIDED ASSEMBLY PROCESS

- Computer manages advancement of the process
- Automated quality control
- Repeatable output
- Minimizes human error
- Each unit get tested (no batch testing)

EVERY POWER CELL TESTED FOR:

- Protection / Reliability Verifications
- Control Power & I/O Function Verification
- Insulation Resistance Test
- Voltage Withstand Test
- Visual inspection

Our internal assembly failure rate is



(assembly errors found in the actual assembly process)

The field assembly failure rate is



(assembly errors found after the product is installed in the field)



Every MV1000 leaves the factory after undergoing a multi point inspection, culminating in a live motor spin test.

SUSTAINABLE SOLUTIONS

Reduced input harmonics combined with motor-friendly output

Yaskawa Smart Harmonics™ Technology and PWM Control
Input Total Harmonic Distortion (THD) < 2.5% without filters!

MINIMIZED INPUT HARMONICS EXCEED GUIDELINES

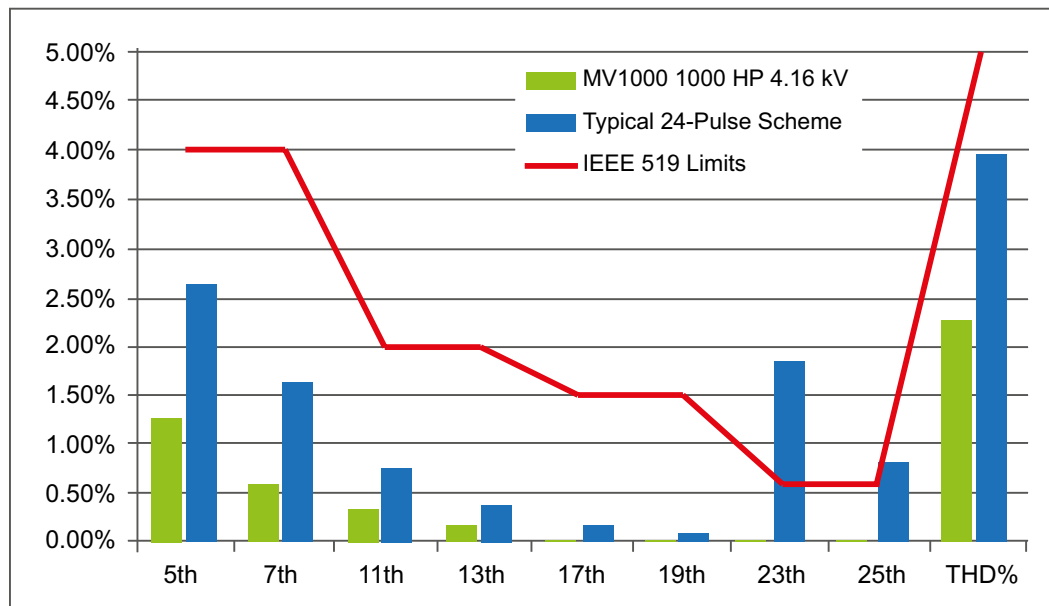

Yaskawa's unique Smart Harmonics™ Technology incorporated in the MV1000 drastically reduces input harmonics

The resulting input waveform is near sinusoidal, exceeding the requirements of IEEE519-1992.

No input filter is necessary.

MEASURED HARMONICS AND INPUT CURRENT

Harmonic	5th	7th	11th	13th	17th	19th	23rd	25th	THD
IEEE 519 Limits	4.00%	4.00%	2.00%	2.00%	1.50%	1.50%	0.60%	0.60%	5%
MV1000 1000 HP 4.16 kV	1.28%	0.56%	0.34%	0.16%	0.03%	0.04%	0.01%	0.01%	2.26%
Typical 24-Pulse Scheme	2.60%	1.60%	0.70%	0.40%	0.20%	0.10%	1.90%	0.80%	3.80%

9/17 LEVEL OUTPUT WAVEFORM USING ENHANCED CASCADING H-BRIDGE CONFIGURATION

MV1000 uses multiple 3-level power cells and requires only two power cells per phase at 4.16 kV

CONFIGURATION OF ONE POWER CELL

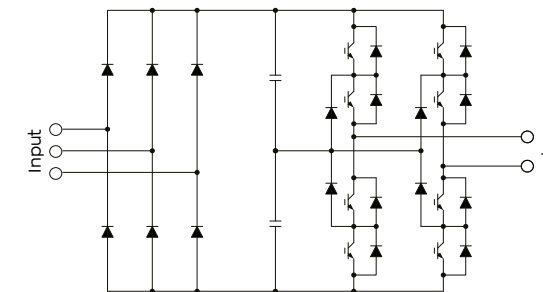

CELL WAVEFORM

Output voltage of single power cell

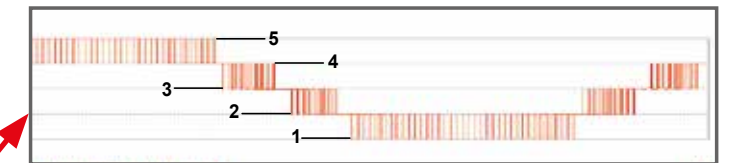

Result is "5-level" waveform

PHASE WAVEFORM

Line to neutral voltage for 4.16 kV drive

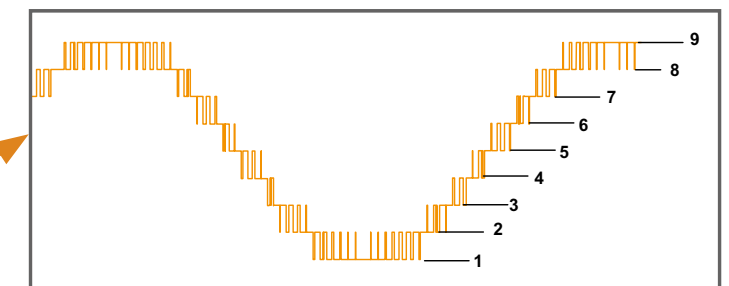

Result is "9-level" waveform

CONFIGURATION OF COMPLETE DRIVE

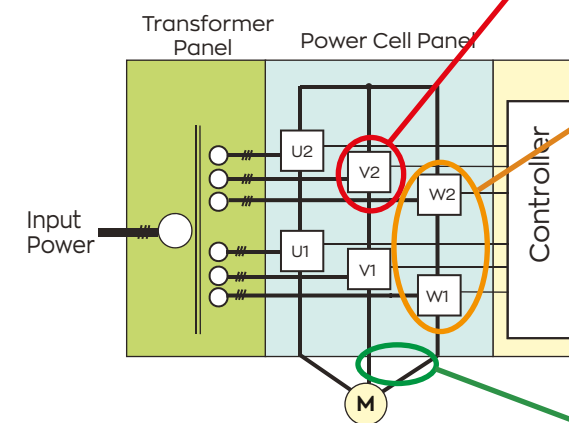

OUTPUT WAVEFORM

Line to line voltage for 4.16 kV drive

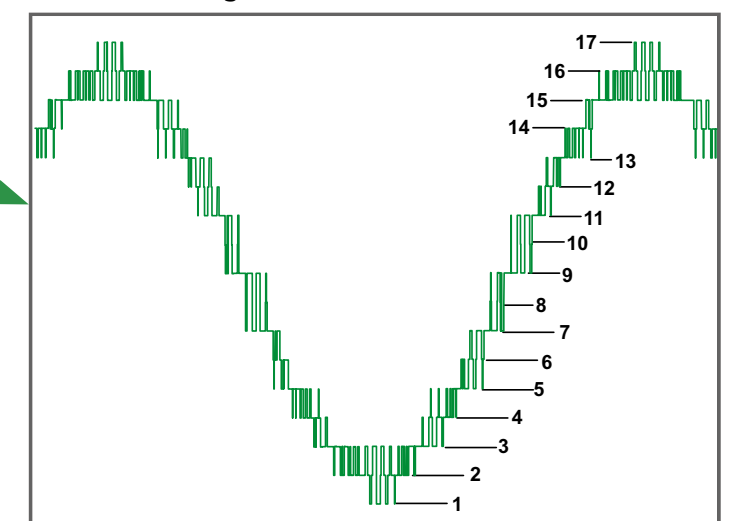

Result is "17-level" line to line voltage waveform applied to motor

PWM control with enhanced Cascading H-Bridge outputs a near sinusoidal Waveform

- Minimal surge voltage (reflected wave phenomenon) protects motor insulation.
- Low torque ripple - smooth mechanical power transmission
- Low audible noise

Motor friendly output allows the use of existing motors without supplemental filtering, even at long lead lengths!

FEATURES

Designed to streamline startup and minimize maintenance

USER FRIENDLY DIGITAL OPERATOR

- Easy to read LCD display
- Same parameters and programming as Yaskawa low voltage drives
- Real-time clock for event logging
- Remote mountable
- Built-in parameter backup



ADVANCED FEATURES

Features to make your installation faster and easier

- Power dip ride-through
- Kinetic energy braking (KEB) function
- Closed loop vector for load sharing or high demand applications
- Closed transition sync transfer and capture
- Speed search
- Automatic restart
- Auto tuning
- Open loop vector
- V/Hz control

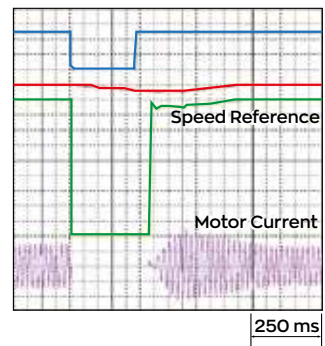

Speed Search Function

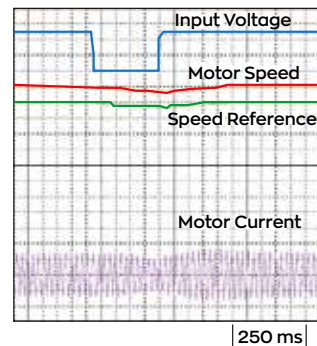

KEB Function

NETWORK COMPATIBILITY

Network control your way through RS-485 communication (Modbus RTU) or other optional major network protocols

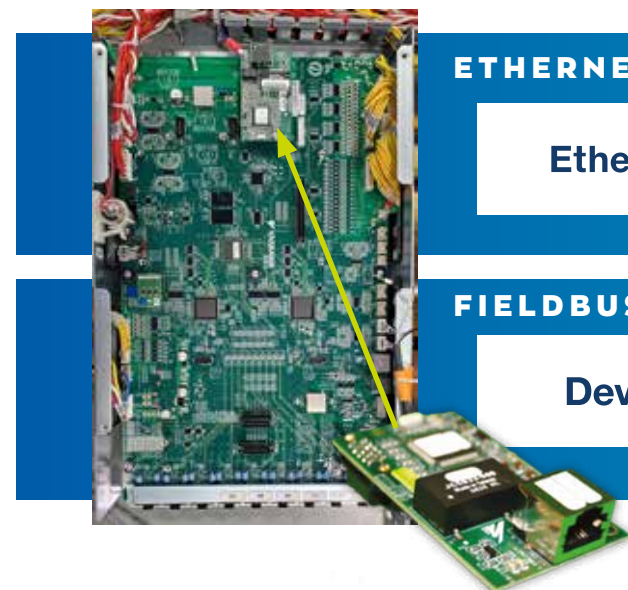

ETHERNET

EtherNet/IP™

Modbus

PROFI NET®

FIELD BUS

DeviceNet™

Modbus RTU

PROFI BUS®

SOFTWARE TOOLS

Whether you are monitoring, programming, or troubleshooting, Yaskawa's PC tools are here to help get you going and stay going.

DRIVEWIZARD® MV

- Manage your parameters online or offline
- Create configurations offline, then connect and download them to the MV1000
- Connect via USB, and interface with the MV1000, even without MV power
- Monitor using a dashboard of dynamic variables
- Create reports for exporting and emailing

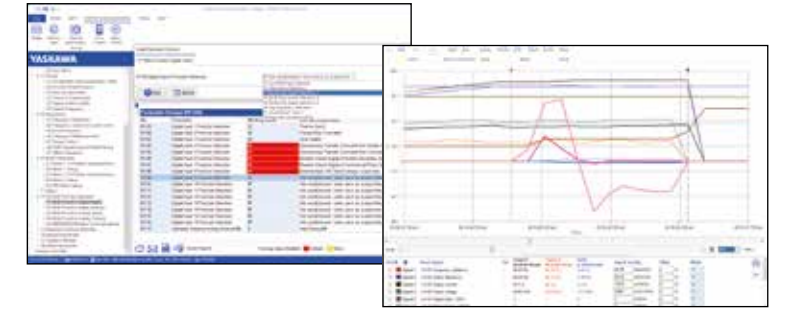

SYNCHRONOUS TRANSFER

Smoothly transfer motor control between the MV1000 and a commercial power supply.

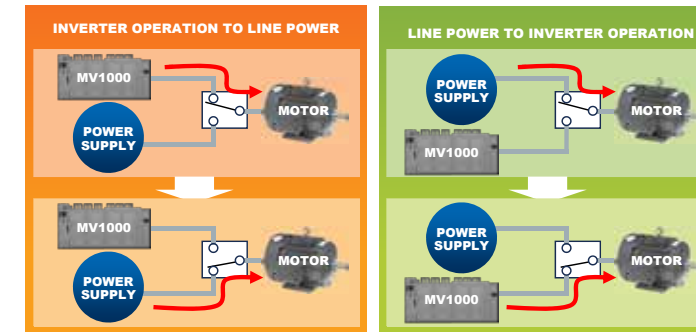

BENEFITS

- Eliminate motor inrush
- Minimize utility impact
- Great for soft power supplies
- Minimize expenses needed for high inrush loads

DRIVE TO UTILITY TRANSFER

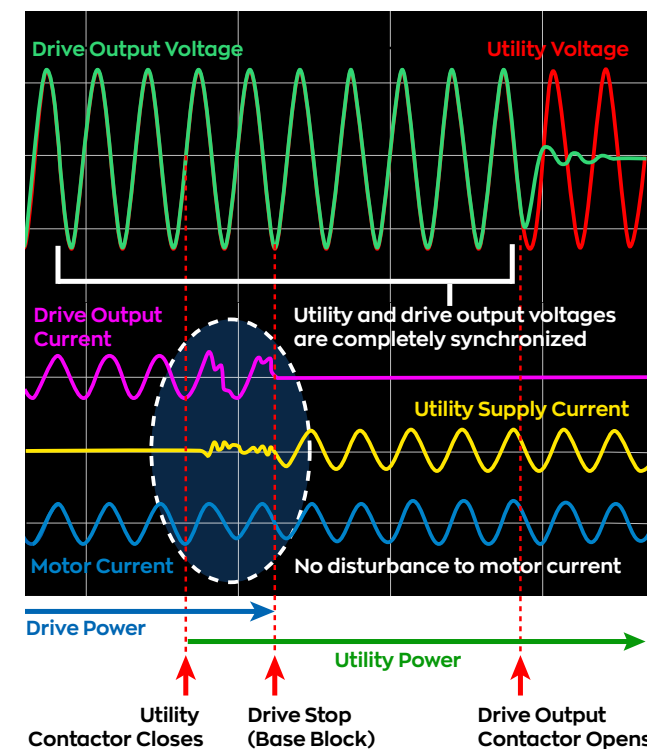

UTILITY TO DRIVE TRANSFER

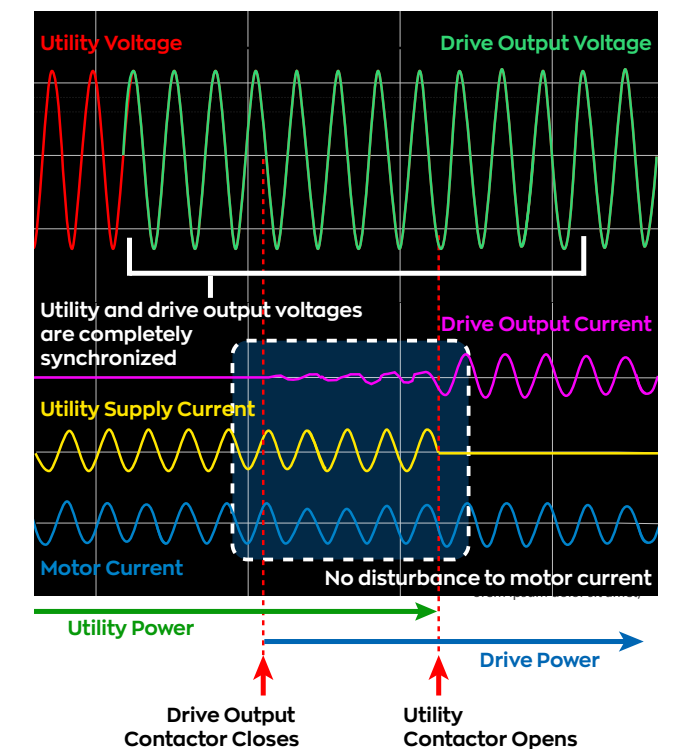

INDUSTRIES SERVED



Oil/Gas

- Midstream Compressors & Pumps
- Oil Field Water Injection Pumps
- High Efficiency Fracking Pumps
- Electrical Submersible Pumps
- SSP/ HSP pumps
- Gas Injection

Chemical and Petrochemical

- Pumps
- Compressors
- Extruders
- Fans

Cement

- Conveyors
- Fans
- Rotary Kilns
- Pumps
- Crushers

Mining

- Slurry Pumps
- Ventilation Fans
- Conveyors
- Crushers
- Dryer Fans

Water/Wastewater Treatment

- Pumps
- Aeration
- Fans

Power Generation

- ID and FD fans
- Conveyors
- Ball Mills
- Bag House Fans

Tire and Rubber

- Banbury Mixers
- Extract Fans
- Conveyors

PRODUCT PORTFOLIO

INDOOR

OUTDOOR



UP TO
10,000
HP



UP TO
6,000
HP

UP TO
2,000
HP

INDOOR FRAME SIZES

1



2.4 kV: up to 600 HP
4.16 kV: up to 1,000 HP

2



2.4 kV: 700 to 1,000 HP
4.16 kV: 1,250 to 2,000 HP

3



2.4 kV: 1,250 to 1,750 HP
4.16 kV: 2,250 to 3,000 HP

5



2.4 kV: 2,000 to 2,750 HP
4.16 kV: 3,500 to 6,000 HP

6



4.16 kV: 7,000 to 10,000+ HP

OPTIMAL PACKAGING DESIGN

Modular design with optimal footprint and maintainability

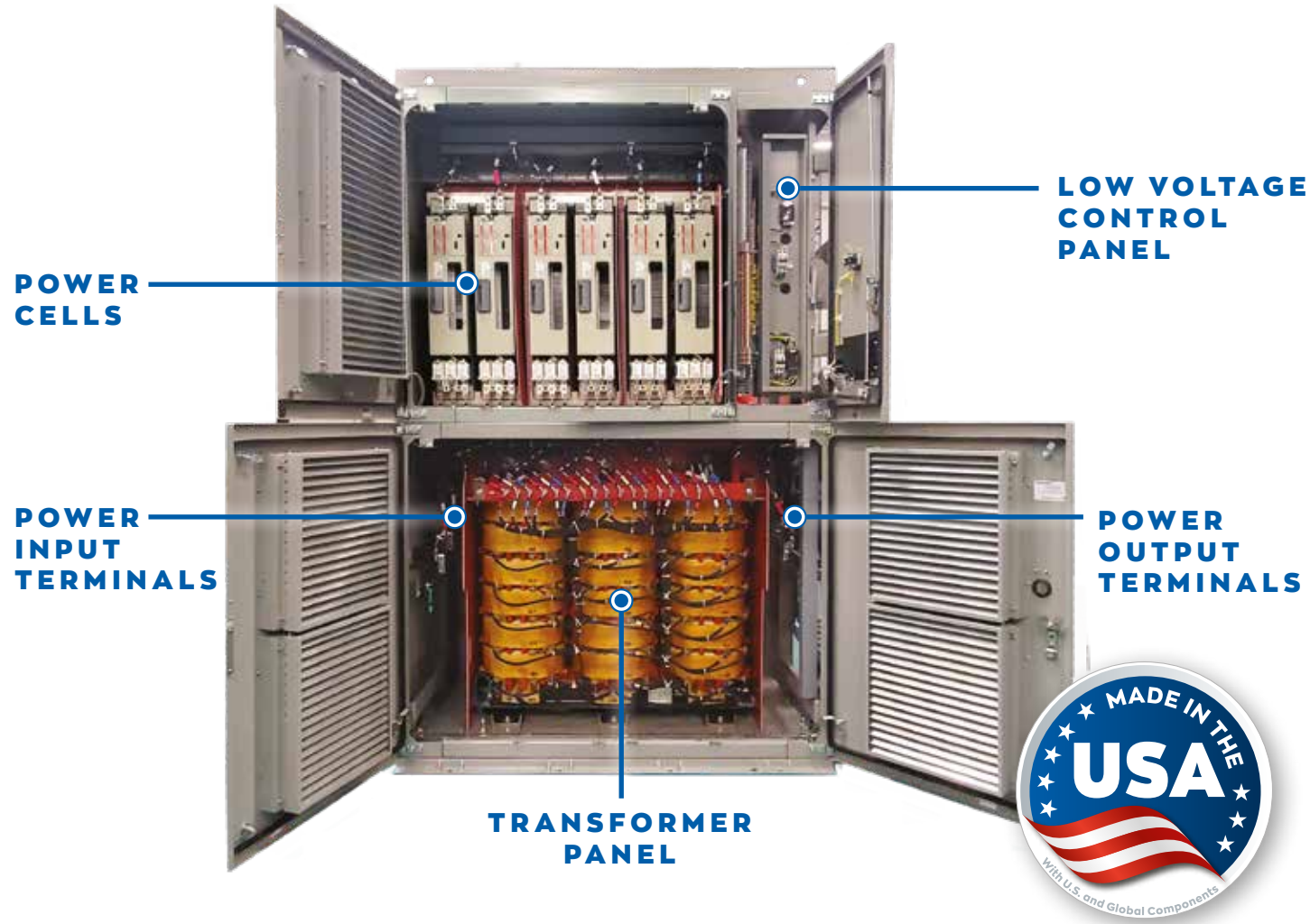

CONTROL PANEL



MAIN CONTROL, RELAYS, AND BREAKERS

- Easy access pull out control panel.
- Houses low voltage components.
- Customer terminations via industrial terminal blocks.
- Low voltage circuitry protected by circuit breakers.
- Main control board communicates to with power cells through fiber optic cables.

Same size & layout for all capacities

INTERNAL BREAKDOWN

POWER CELLS

- Six power cells, two per phase (2.4 kV and 4.16 kV output)
- Fuse protection on each power cell
- Control and monitoring via single fiber optic cable per power cell
- IGBT temperature monitors
- Easy cell replacement in 15 minutes



TRANSFORMER

- 36 pulse, patented isolation transformer
- Galvanic isolation
- Double insulated windings
- Winding temperature monitoring and protection
- +/- 5% taps

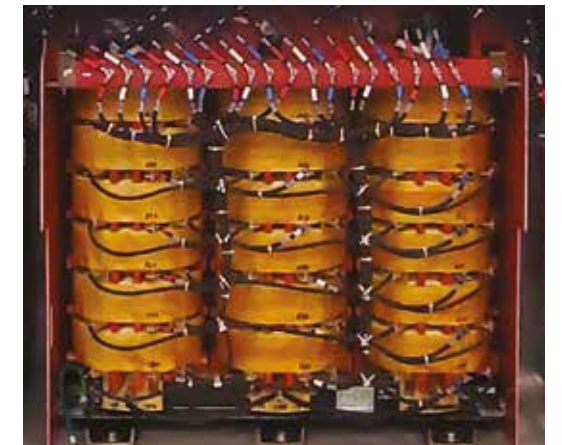

INPUT SWITCHGEAR (OPTIONAL)

- Integrated isolation switch
- E-rated, current limiting fuses
- Vacuum contactor for interrupting circuit
- All CSA/UL rated components

PRODUCT RANGE

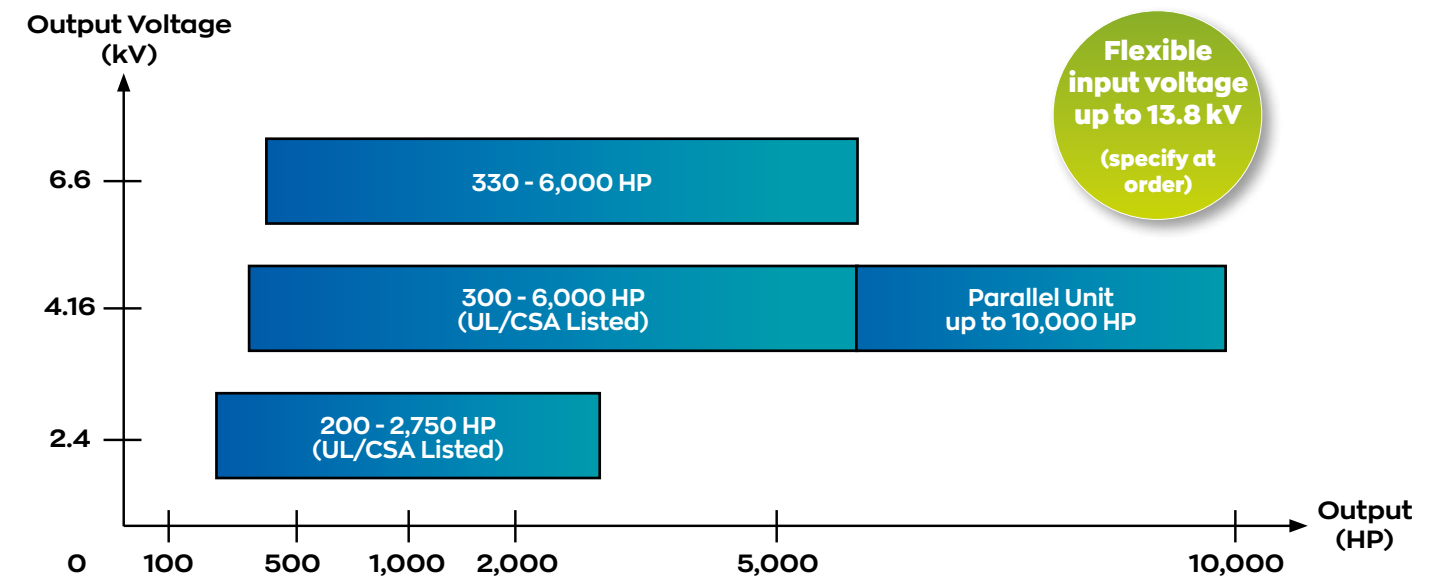

OUTDOOR NEMA 3R

Totally enclosed solution ideal for -5°C to +50°C* outdoor installations

Input Switchgear

- Non-load break switch
- E-Rated current limiting fuses
- Vacuum contactor for load interruption
- All UL / CSA rated components
- Viewing window

Heat Exchangers

- Fully sealed
- Air to air heat transfer
- High efficiency

Space for Options

- Additional control I/O
- Sync. transfer reactor
- Sine wave filter
- Output reactor

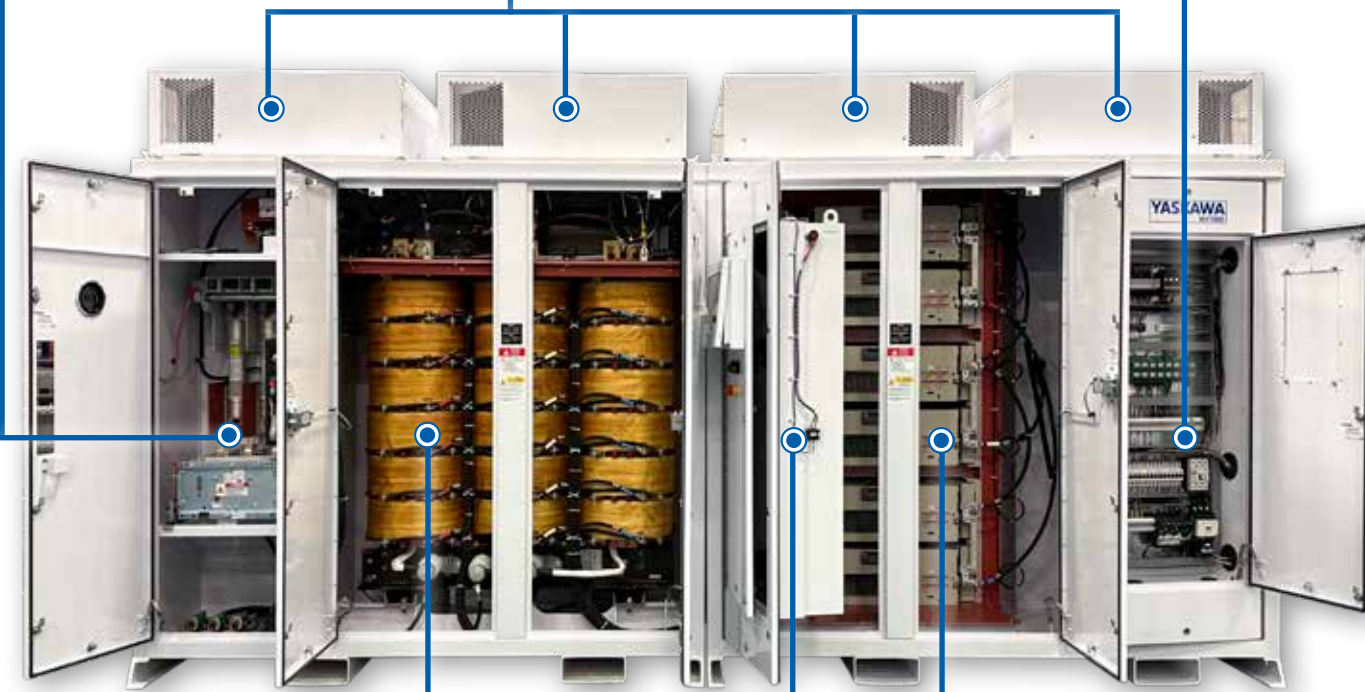

Transformer Section

- 36-pulse patented design
- Galvanic isolation
- Double insulated windings
- Winding temperature monitoring and protection
- 5% taps
- Surge protected primary

Control Section

- Easy access to most control devices
- Control wiring interface
- Main processor
- Digital input/outputs
- Isolated analog inputs/outputs
- Fan control/monitoring boards

Power Cell Section

- Six cells, two per phase
- Fuse protection on each cell
- Control and monitoring via single fiber optic cable per cell
- IGBT temperature monitors
- Easy cell replacement in 15 minutes

* Output derate may apply above 40°C

TESTED TOUGH

Yaskawa builds upon its proven track record for quality, performance and reliability of medium voltage drives with the MV1000 NEMA 3R, our outdoor-rated version of the MV1000.

Reduce Capex and Opex
Fastest System Delivery



Designed as a standalone solution, the MV1000 NEMA 3R package sets the standard for all your outdoor application needs.

PRODUCT RANGE

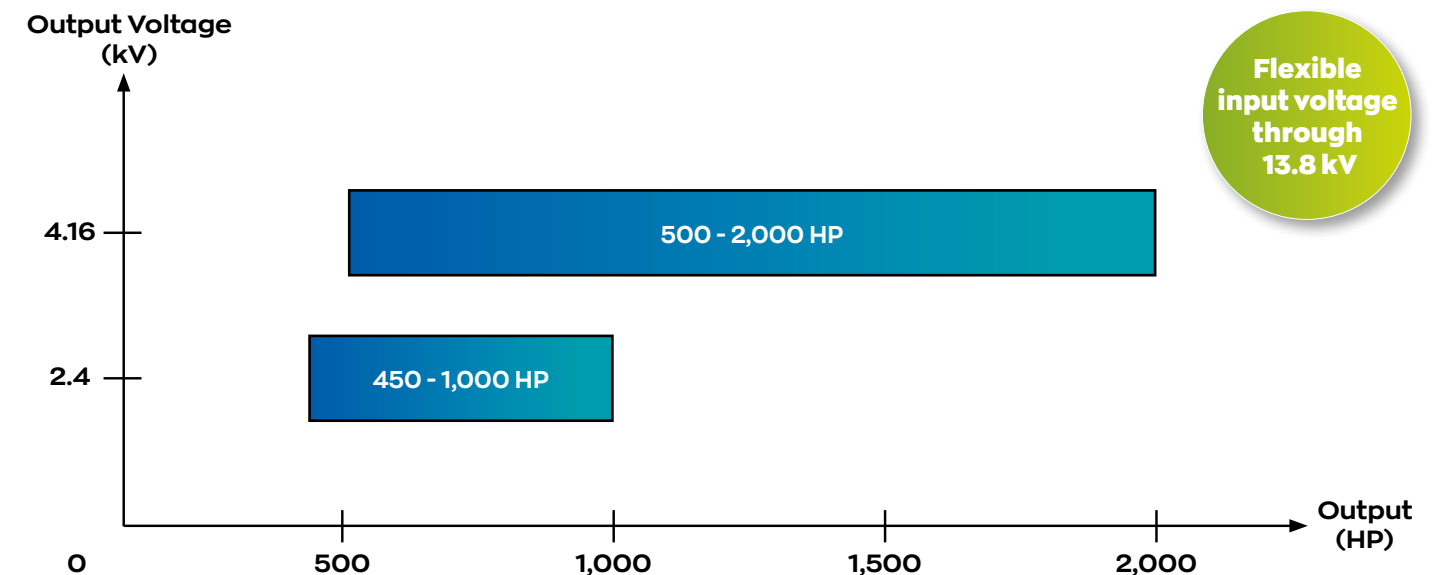

ALL WEATHER DRIVE

The All Weather Drive is an MV1000 outdoor solution that extends the NEMA 3R power range to 6,000 HP at 4,160 output volts. Tested to withstand extreme outdoor conditions, from the heat and dust of the arid desert to the bitter cold of the tundra (-45°C to +50°C), this solution can operate in most every outdoor environment.



DESIGNED FOR ALL CLIMATE CONDITIONS



TOTALLY ENCLOSED SOLUTION



Input Switchgear

- Integrated isolation switch
- High capacity circuit breaker
- Integral protection relay
- Surge protection
- Local and/or remote control



Transformer

- 36-pulse patented isolation transformer
- Galvanic isolation
- Double insulated windings
- Winding temperature monitoring and protection
- +/-5% taps
- Surge protected primary



Power Cells

- Six cells, two per phase (2.4 kV and 4.16 kV output)
- Fuse protection on each cell
- Control and monitoring via single fiber optic cable per power cell
- IGBT temperature monitors
- Easy cell replacement in 15 minutes

THERMAL MANAGEMENT SYSTEM

- Automatic control of the internal temperature of the enclosure
- Eco-Friendly, no refrigerant required
- Internal heaters to avoid condensation
- Wide range of operation (-45°C to +50°C)
- User friendly controls
- Local and remote control
- Alarm and fault logging



MODELS & RATINGS

INDOOR DRIVES

CIMR-MV2 U D 6 D A 125 E1 A I B

Product Type
Drive

Product Series
MV1000 Series

Region Code
U : U.S.A.

Input Voltage
A : 2.4 kV
D : 4.16 kV
J : 13.8 kV

Note: Other input voltages available up to 15 kV. Please consult Yaskawa.

Input Frequency
6 : 60 Hz

Output Voltage Class
A : 2 kV Class
D : 4 kV Class
F : 6 kV Class

Note: All input voltages are not necessarily compatible with all output voltage classes.

Custom Specification
F : Standard

Input Switchgear
A : without input switchgear
B : with input switchgear

Control Option
B : 240/120 V Control

Environmental Spec.
A : Standard

Enclosure Type
E1 : IP40 (NEMA Type 1)
E2 : NEMA Type 12

Output Current			
2.3 kV Units	4.16 kV Units		6.6 kV Units
052 : 52 A	039 : 39 A	340 : 340 A	035 : 35 A
068 : 68 A	052 : 52 A	375 : 375 A	050 : 50 A
080 : 80 A	058 : 58 A	440 : 440 A	070 : 70 A
093 : 93 A	064 : 64 A	505 : 505 A	100 : 100 A
102 : 102 A	077 : 77 A	575 : 575 A	140 : 140 A
115 : 115 A	093 : 93 A	625 : 625 A	200 : 200 A
135 : 135 A	102 : 102 A	650 : 650 A	260 : 260 A
160 : 160 A	115 : 115 A	700 : 700 A	330 : 330 A
180 : 180 A	125 : 125 A	800 : 800 A	400 : 400 A
205 : 205 A	155 : 155 A	870 : 870 A	520 : 520 A
220 : 220 A	190 : 190 A	990 : 990 A	650 : 650 A
280 : 280 A	220 : 220 A	B20 : 1120 A	
330 : 330 A	250 : 250 A	C35 : 1235 A	
390 : 390 A	285 : 285 A	D50 : 1350 A	
440 : 440 A	315 : 315 A	F25 : 1525 A	
505 : 505 A			
550 : 550 A			
600 : 600 A			

3.3 kV, 7.2 kV, and 11 kV output models also available. Please consult Yaskawa.

OUTDOOR DRIVES

CIMR-MV2 U D 6 D A 125 OD A I B

Product Type
Drive

Product Series
MV1000 Series

Region Code
U : U.S.A.

Input Voltage
A : 2.4 kV
D : 4.16 kV

Note: Other input voltages available up to 15 kV. Please consult Yaskawa.

Input Frequency
6 : 60 Hz

Output Voltage Class
A : 2 kV Class
D : 4 kV Class
F : 6 kV Class

Note: All input voltages are not necessarily compatible with all output voltage classes.

Custom Specification
A : Standard A
B : Standard B

Input Switchgear
A : None
B : with input switchgear

Control Voltage Class
I : Internal PT

Environmental Spec.
A : Standard

Enclosure Type
OD : Outdoor Rated

Output Current			
2.4 kV Units		4.16 kV Units	
No.	Current (HP)	No.	Current (HP)
102	102A (450)	064	64A (500)
135	135A (600)	102	102A (800)
220	220A (1000)	125	125A (1000)
		190	190A (1500)
		250	250A (2000)
		315	315A (2500)
		375	375A (3000)
		440	440A (3500)
		505	505A (4000)
		575	575A (4500)
		625	625A (5000)
		700	700A (5500)
		800	800A (6000)

Note:
4.16 kV standard NEMA 3R drive is available from 64 A (500 HP) through 250 A (2000 HP).
The All Weather Drive's NEMA 3R solution is available from 315 A (2500 HP) through 800 A (6000 HP).

COMMON SPECIFICATIONS

Item	Specifications
Control Characteristics	Control Methods: V/f Control (V/f), Open Loop Vector Control (OLV), Closed Loop Vector Control (CLV)
Frequency Control Range	0.01 to 120 Hz
Frequency Accuracy (Temperature Fluctuation)	Digital input: within ±0.01% of the max output frequency (-10°C to +40°C) Analog input: within ±0.5% of the max output frequency (-10°C ± 40°C)
Frequency Setting Resolution	Digital inputs: 0.01 Hz Analog inputs: 1/2048 of the maximum output frequency setting (11 bit plus sign)
Output Frequency Resolution	0.001 Hz
Frequency Setting Methods	0 to +10 V, 4 to 20 mA
Starting Torque	V/f: 130% at 3 Hz, OLV: 130% at 0.3 Hz, CLV: 130% at 0 r/min
Speed Control Range	V/f: 1:20, OLV: 1:100, CLV: 1:1000
Speed Control Accuracy	V/f: ± 2 to 3%, OLV: ± 0.5%, (25°C ± 10°C), CLV: ± 0.02% (25°C ± 10°C)
Speed Response	OLV: 10 Hz, CLV: 50 Hz
Accel/Decel Time	0.0 to 6000.0 s (4 selectable combinations of independent acceleration and deceleration settings)
Protection Function	Motor Protection: Electronic thermal overload relay
Momentary Overcurrent Protection	Drive stops when output current exceeds 132%
Overload Protection	Drive stops after 60 s at 110% of rated output current
Overvoltage Protection	Power Cell VPN > 1035 VDC
Undervoltage Protection	Power Cell VPN < 300 VDC
Momentary Power Loss Ride-Thru	Resumes operation if power loss is less than 2 s (standard) (UPS Required)
Overheat Protection	Power Cell = Thermistor, Transformer = PT100 and Thermal Switch
Ground Fault Protection	Electronic circuit protection
Operating Environment	Ambient Temperature: Type 1 Models: -5°C to 40°C (50°C with derate) Standard NEMA 3R Models: -5°C to 50°C (derate may apply above 40°C) All Weather Drive Models: -45°C to 50°C
Humidity	95% RH or less (no condensation)
Storage Temperature	-20°C to +60°C (short-term temperature during transportation)
Altitude	Up to 2000 m without derating, up to 4000 m with output current and voltage derating
Comm. Options	Communications Protocols (Optional): EtherNet/IP, DeviceNet, Modbus TCP/IP, Modbus RTU, PROFIBUS DP, and PROFINET

ENGINEERING & SUPPORT

ENGINEERING CAPABILITY

Yaskawa has the engineering capability to design and build UL packages that meet any customer needs. Synchronous transfer, bypass, heater circuits, meters, and a wide range of accessories and options can be quoted and delivered in minimal time. Let Yaskawa deliver to your specific needs.

TECHNICAL TRAINING

Both standard and customized courses are available with hands-on activities and demonstrations. Instruction is offered at Yaskawa locations as well as traveling road schools, and is supplemented by live web classes and e-Learning modules / videos to provide the right level of training to fit your needs. Trainers are degreed engineers with extensive industry experience who train over 3,000 customers worldwide each year, with thousands more viewing learning modules online.



Traveling Road Show Van



YASKAWA SOLUTION CENTER

The Yaskawa Solution Center is a web portal for learning about all things Yaskawa. More specifically, it is designed to help customers get specific support for their product questions and needs.

We recognize that our customers may not want to get help only by phone. That's why we created the Yaskawa Solution Center, an online tool to readily find resources for things like:

- Step-by-step instructions, including video tutorials
- Help configuring a product for a new application
- Starting up a product for the first time
- Transitioning from an older legacy product to a current one

This information is delivered via technical documents and manuals, video, and authored content based on real case scenarios in real time.

The Solutions Center also includes a crowd-sourcing feature. By allowing all visitors to provide feedback on anything they find on the site, we can improve, correct and add content. Even Yaskawa sales associates continuously submit feedback to content based on what they see and learn in the field. The site is literally updated in real time!

All of this collaboration between Yaskawa associates, distributors, OEMs and end-users makes the Solution Center more and more valuable to our customers every day.



Crowd-Sourcing Feature Content is continuously added and updated in real time.

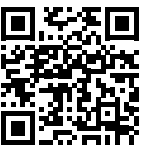

WORLDWIDE CUSTOMER SUPPORT

Yaskawa offers worldwide support with application assistance, start up, maintenance, troubleshooting and repair, as well as internet tools and telephone support. Sales and service offices are located around the world.

SUPPORT AVAILABLE

24/7/365

In the Americas, telephone assistance is available 24/7/365 at 1-800-YASKAWA (927-5292). Our phone support group is product certified to assist you with current and legacy drive requirements.

Yaskawa's Field Service personnel can provide on-site start-up assistance, troubleshooting, and repair.



The Customer Relationship Management Institute has honored Yaskawa with the NorthFace ScoreBoard Award nine years running for excellence in technical support.

VISIT [HTTPS://SOLUTIONCENTER.YASKAWA.COM/](https://solutioncenter.yaskawa.com/)

Bridging the gap between what you are trying to do and the technical information you need to accomplish it.

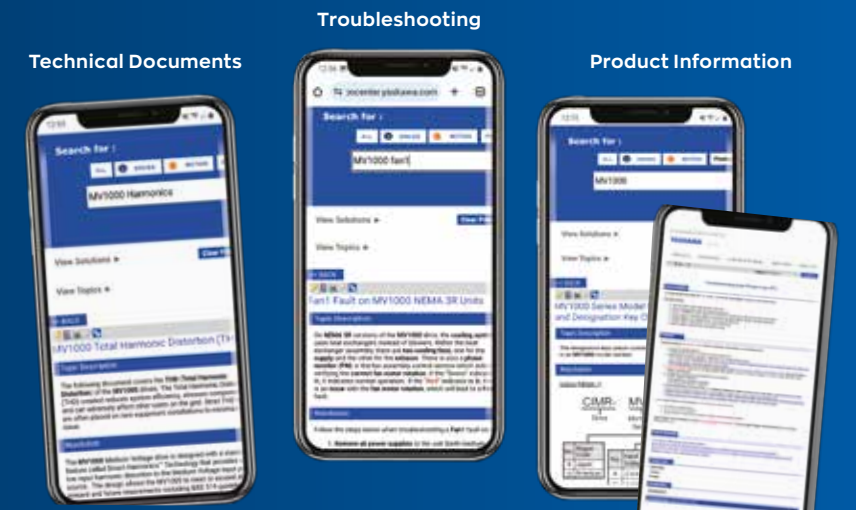

YASKAWA.COM



Yaskawa is the leading global manufacturer of low and medium voltage variable frequency drives, servo systems, machine controllers and industrial robots. Our standard products, as well as tailor-made solutions, are well known and have a high reputation for outstanding quality and reliability.

YASKAWA

Yaskawa America, Inc. | Drives & Motion Division

1-800-YASKAWA | Email: info@yaskawa.com | yaskawa.com

Document No. BL.MV1000.01 | 03/02/2024 | © 2018 Yaskawa America, Inc.